

1988 Voyager PARTS DIAGRAM

Air Cleaner

E1130-0137

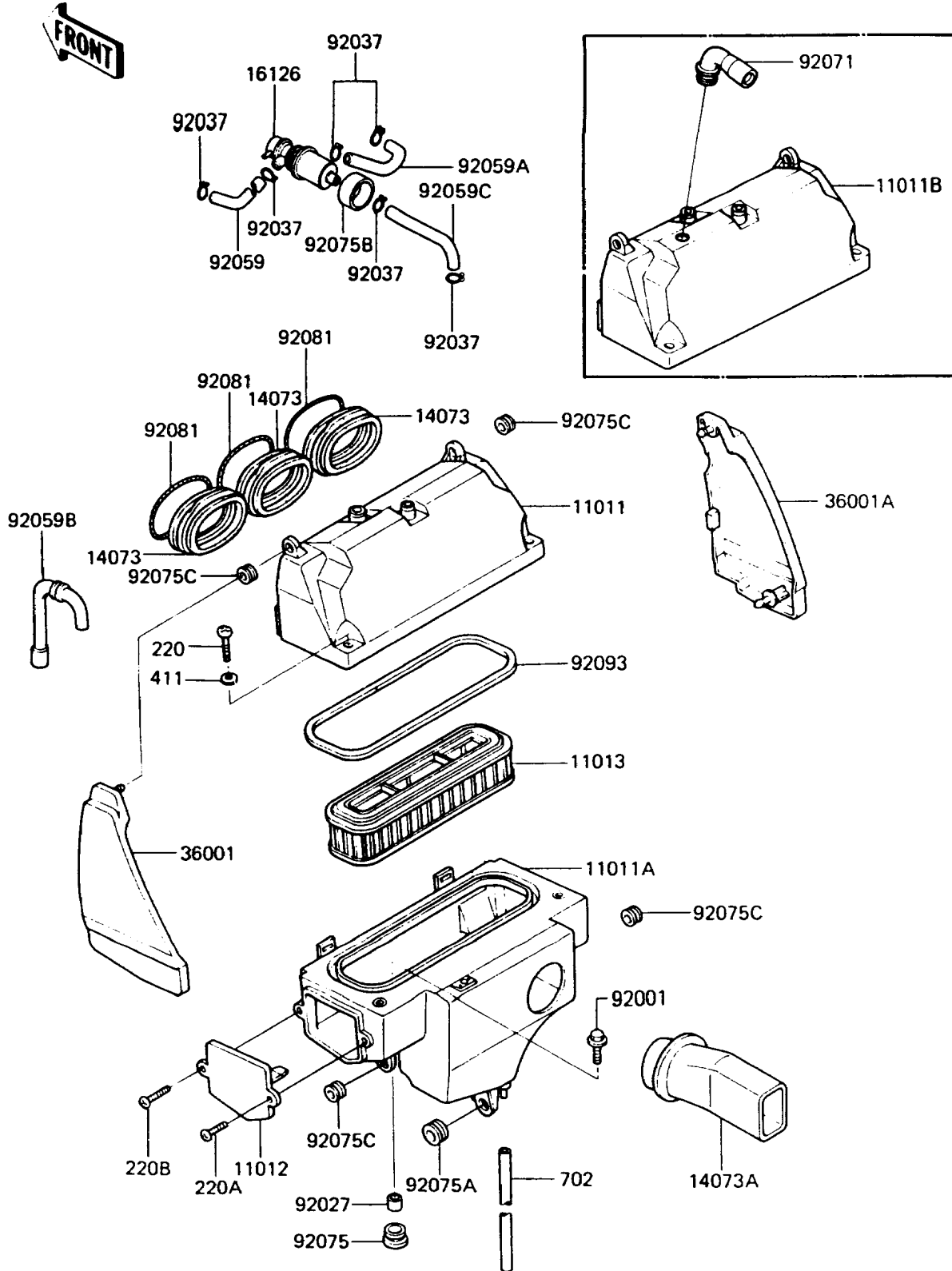

1988 Voyager PARTS LIST

Air Cleaner

ITEM NAME	PART NUMBER	QUANTITY
CASE-AIR FILTER,UPP (Ref # 11011)	11011-1132	1
CASE-AIR FILTER,LWR (Ref # 11011A)	11011-1133	1
CASE-AIR FILTER,UPP (Ref # 11011B)	11011-1171	1
CAP,AIR FILTER (Ref # 11012)	11012-1285	1
ELEMENT-AIR FILTER (Ref # 11013)	11013-1073	1
DUCT,AIR FILTER (Ref # 14073)	14073-1098	3
DUCT,AIR FILTER (Ref # 14073A)	14073-1099	1
VALVE,AIR SWITCHING (Ref # 16126)	16126-1015	1
COVER-SIDE,AIR FILTER,LH (Ref # 36001)	36001-1202	1
COVER-SIDE,AIR FILTER,RH (Ref # 36001A)	36001-1203	1
BOLT,6X25,W/WASHER (Ref # 92001)	92001-1140	2
COLLAR,6.8X10X10.5 (Ref # 92027)	92027-120	2
CLAMP,TUBE (Ref # 92037)	92037-213	6
TUBE,SWITCH VALVE,LH (Ref # 92059)	92059-1076	1
TUBE,SWITCH VALVE,RH (Ref # 92059A)	92059-1077	1
TUBE,AIR FILTER (Ref # 92059B)	92059-1266	1
TUBE,AIRCUT VALVE (Ref # 92059C)	92059-1272	1
GROMMET,AIR FILTER (Ref # 92071)	92071-1114	1
DAMPER,AIR FILTER (Ref # 92075)	92075-1124	2
DAMPER,FILTER COVER (Ref # 92075A)	92075-1126	1
DAMPER,AIR SWITCH VALVE (Ref # 92075B)	92075-1195	1
DAMPER (Ref # 92075C)	92075-1470	4
SPRING,COIL,3.6X237.2 (Ref # 92081)	92081-1540	3
SEAL,AIR FILTER (Ref # 92093)	92093-1088	1
SCREW-PAN-CROS,6X30 (Ref # 220)	220B0630	2
SCREW-PAN-CROS,6X20,BLACK (Ref # 220A)	220C0620	1
SCREW-PAN-CROS,6X30,BLACK (Ref # 220B)	220C0630	1
WASHER-PLAIN,6MM (Ref # 411)	411B0600	2
TUBE-RUBBER,6X110 (Ref # 702)	702A06110	1