

1988 Voyager PARTS DIAGRAM

Drive Shaft/Final Gear

E3132-0007

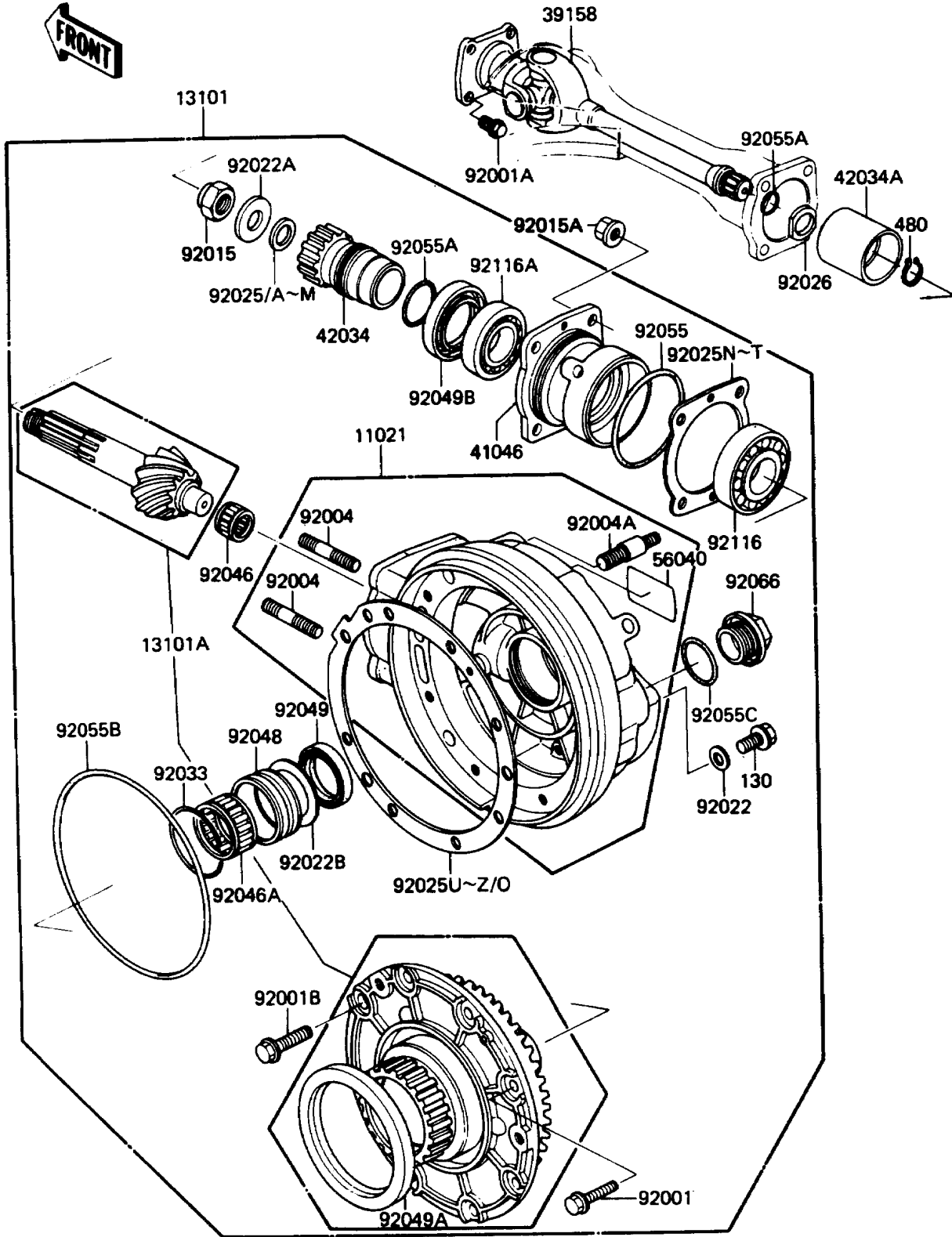

1988 Voyager PARTS LIST

Drive Shaft/Final Gear

ITEM NAME	PART NUMBER	QUANTITY
CASE-ASSY,FINAL GEAR,NO.2 GOLD (Ref # 11021)	11021-1019-F6	1
GEAR-ASSY,FINAL NO.2 GOLD (Ref # 13101)	13101-1033-F6	1
GEAR-ASSY,BEVEL,RR (Ref # 13101A)	13101-5041	1
SHAFT-ASSY-DRIVE (Ref # 39158)	39158-1008	1
HOUSING-BEARING,FINAL (Ref # 41046)	41046-1020	1
COUPLING,PROPELLER SHAFT,INNER (Ref # 42034)	42034-1023	1
COUPLING,PROPELLER SHAFT,OUTER (Ref # 42034A)	42034-1037	1
LABEL-WARNING,OIL (Ref # 56040)	56040-1047	1
BOLT,FLANGED,8X28 (Ref # 92001)	92001-1095	7
BOLT,FLANGED,12X15 (Ref # 92001A)	92001-1139	4
BOLT,FLANGED,10X23 (Ref # 92001B)	92001-1778	1
STUD,10X31.5 (Ref # 92004)	92004-1021	4
STUD,RR SHOCKABSORBER (Ref # 92004A)	92004-1047	1
NUT,16MM (Ref # 92015)	92015-1059	1
NUT,FLANGED,10MM (Ref # 92015A)	92015-1415	4
WASHER,8.2X16X1 (Ref # 92022)	92022-1086	1
WASHER,16X32X3.2 (Ref # 92022A)	92022-1105	1
WASHER,39X49.5X1 (Ref # 92022B)	92022-1294	1
SHIM,T=1.30 (Ref # 92025)	92025-1214	AR
SHIM,T=1.32 (Ref # 92025A)	92025-1215	AR
SHIM,T=1.34 (Ref # 92025B)	92025-1216	AR
SHIM,T=1.36 (Ref # 92025C)	92025-1217	AR
SHIM,T=1.38 (Ref # 92025D)	92025-1218	AR
SHIM,T=0.10 (Ref # 92025E)	92025-1219	AR
SHIM,T=0.20 (Ref # 92025F)	92025-1220	AR
SHIM,T=0.30 (Ref # 92025G)	92025-1221	AR
SHIM,T=0.50 (Ref # 92025H)	92025-1222	AR
SHIM,T=0.60 (Ref # 92025I)	92025-1223	AR
SHIM,T=0.70 (Ref # 92025J)	92025-1224	AR

1988 Voyager PARTS LIST

Drive Shaft/Final Gear

ITEM NAME	PART NUMBER	QUANTITY
SHIM,T=0.80 (Ref # 92025K)	92025-1225	AR
SHIM,T=0.90 (Ref # 92025L)	92025-1226	AR
SHIM,T=1.00 (Ref # 92025M)	92025-1227	AR
SHIM,T=0.10 (Ref # 92025N)	92025-1388	AR
SHIM,T=0.15 (Ref # 92025O)	92025-1389	AR
SHIM,T=0.20 (Ref # 92025P)	92025-1390	AR
SHIM,T=0.30 (Ref # 92025Q)	92025-1391	AR
SHIM,T=0.60 (Ref # 92025R)	92025-1392	AR
SHIM,T=0.90 (Ref # 92025S)	92025-1393	AR
SHIM,T=1.20 (Ref # 92025T)	92025-1394	AR
SHIM,T=0.10 (Ref # 92025U)	92025-1625	AR
SHIM,T=0.15 (Ref # 92025V)	92025-1626	AR
SHIM,T=0.20 (Ref # 92025W)	92025-1627	AR
SHIM,T=0.30 (Ref # 92025X)	92025-1628	AR
SHIM,T=0.60 (Ref # 92025Y)	92025-1629	AR
SHIM,T=0.90 (Ref # 92025Z)	92025-1630	AR
SHIM,T=1.20 (Ref # 920250)	92025-1631	AR
SPACER,PROPELLER SHAFT (Ref # 92026)	92026-1085	1
RING-SNAP,52MM (Ref # 92033)	92033-1074	1
BEARING-NEEDLE,K18X25X17 (Ref # 92046)	92046-1056	1
BEARING-NEEDLE,KTV384620E01 C3 (Ref # 92046A)	92046-1057	1
RACE,ORT465021E01 (Ref # 92048)	92048-1019	1
SEAL-OIL,S-35477HS (Ref # 92049)	92049-1025	1
SEAL-OIL,S-901159HS (Ref # 92049A)	92049-1026	1
SEAL-OIL,SC32558 (Ref # 92049B)	92049-1082	1
RING-O,67MM (Ref # 92055)	92055-1032	1
RING-O,ID=32.7 (Ref # 92055A)	92055-1037	2
RING-O,154MM (Ref # 92055B)	92055-1165	1
RING-O,35.8MM (Ref # 92055C)	92055-1281	1

1988 Voyager PARTS LIST

Drive Shaft/Final Gear

ITEM NAME	PART NUMBER	QUANTITY
PLUG,36MM,NO.2 GOLD (Ref # 92066)	92066-1006-F6	1
BEARING-ROLLER,4T30305C (Ref # 92116)	92116-1002	1
BEARING-ROLLER,4T30205 (Ref # 92116A)	92116-1003	1
BOLT-FLANGED,8X12 (Ref # 130)	130B0812	1
CIRCLIP-TYPE-C,26MM (Ref # 480)	480J2600	1