

# 1987 Voyager PARTS DIAGRAM

Brake Pedal/Torque Link

F2260-0189

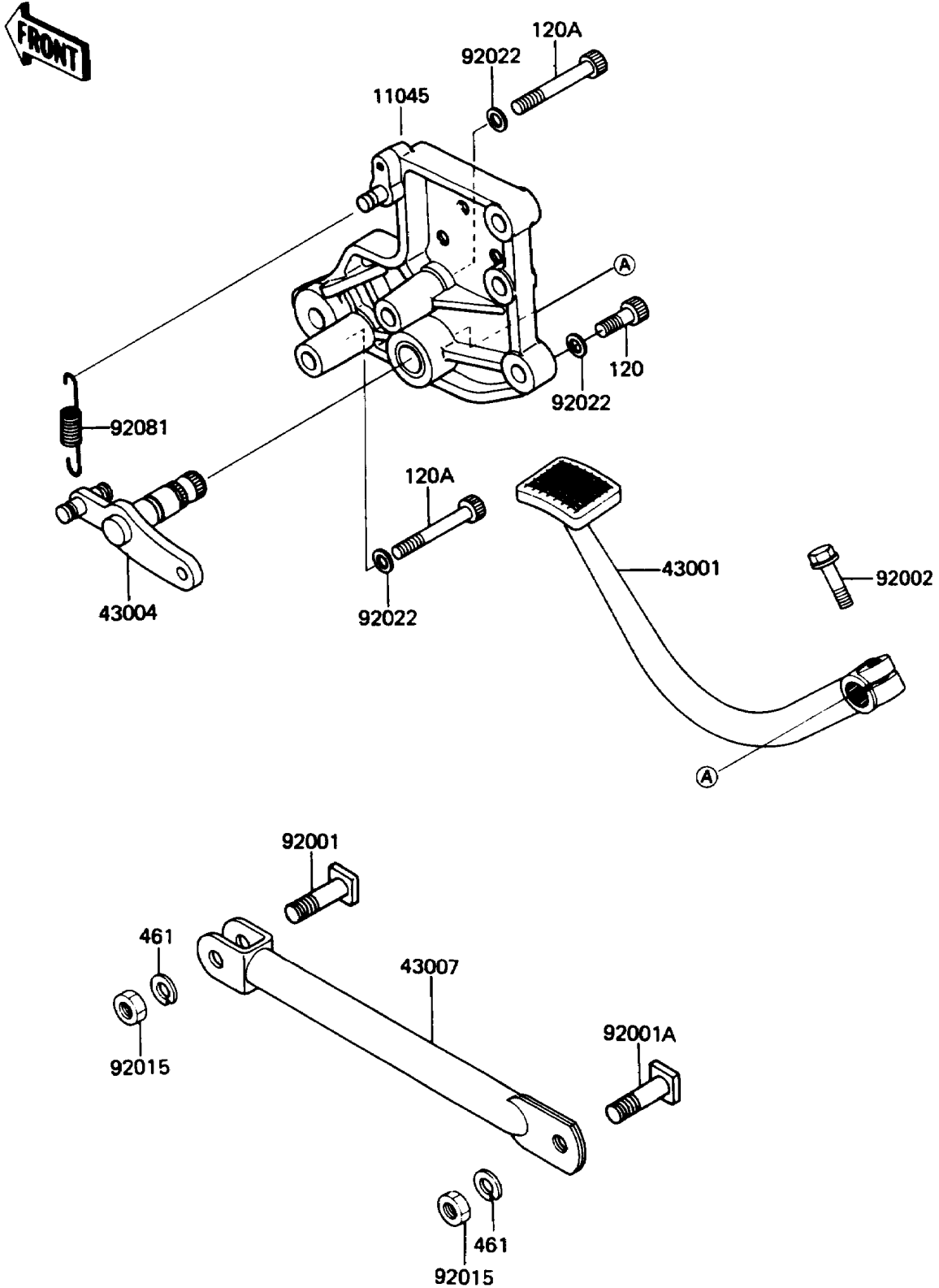

# 1987 Voyager PARTS LIST

## Brake Pedal/Torque Link

ITEM NAME	PART NUMBER	QUANTITY
BRACKET,BRAKE PEDAL (Ref # 11045)	11045-1981	1
LEVER-BRAKE,PEDAL (Ref # 43001)	43001-1241	1
SHAFT-BRAKE (Ref # 43004)	43004-1052	1
ROD-TORQUE,L=250 (Ref # 43007)	43007-1044	1
BOLT,10X37,BLACK (Ref # 92001)	92001-1646	1
BOLT,10X27 (Ref # 92001A)	92001-1891	1
BOLT,FLANGED,8X25 (Ref # 92002)	92002-1201	1
NUT,LOCK,10MM,BLACK (Ref # 92015)	92015-1189	2
WASHER,9X15.5X2 (Ref # 92022)	92022-1401	3
SPRING,BRAKE PEDAL (Ref # 92081)	43005-029	1
BOLT-SOCKET,8X25,BLACK (Ref # 120)	120S0825	1
BOLT-SOCKET,8X55 (Ref # 120A)	120S0855	2
WASHER-SPRING,10MM,BLACK (Ref # 461)	461K1000	2