

1988 Voyager PARTS DIAGRAM

Rear Brake

F2294-0017

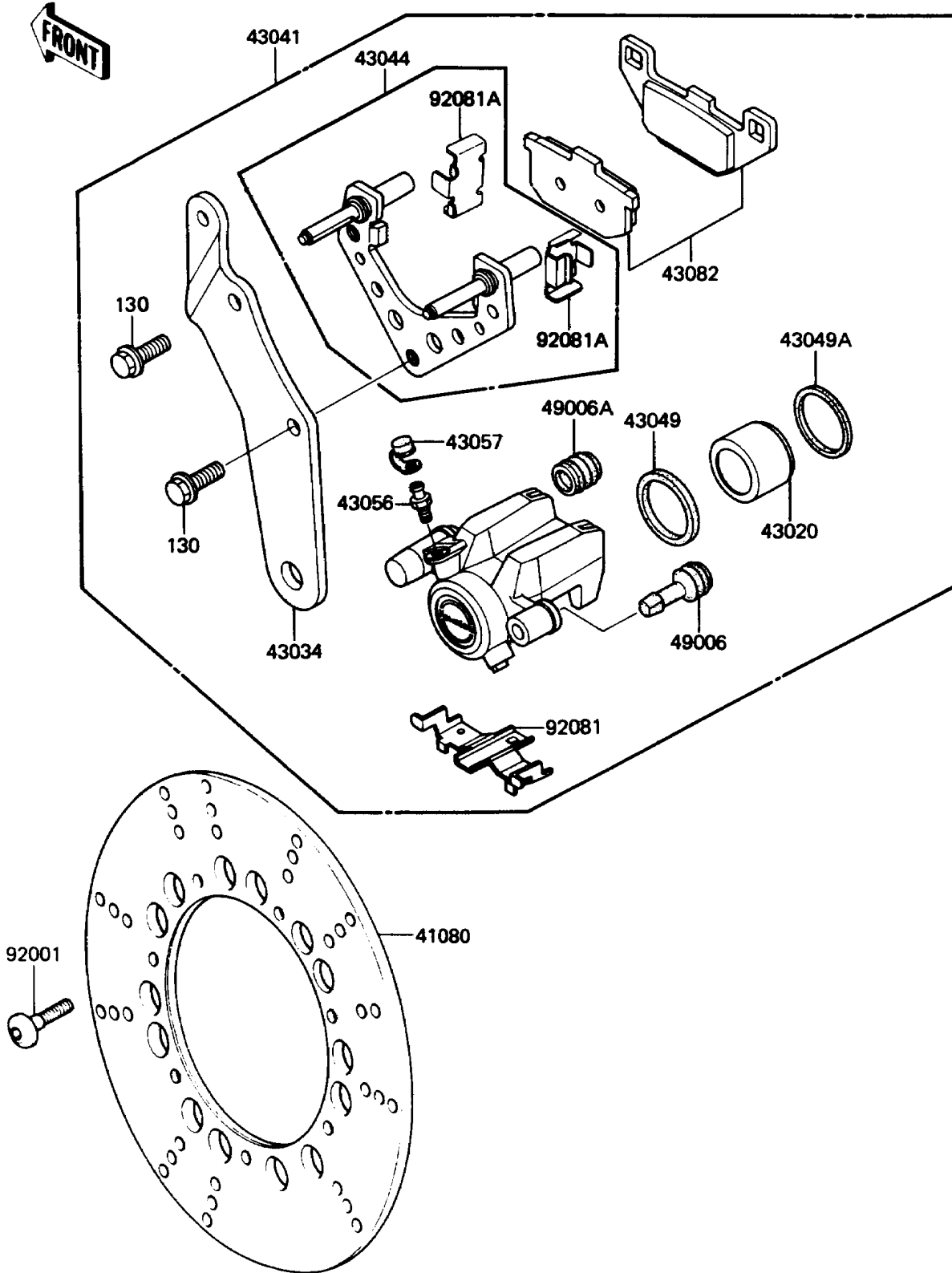

1988 Voyager PARTS LIST

Rear Brake

ITEM NAME	PART NUMBER	QUANTITY
DISC,RR,SILVER (Ref # 41080)	41080-1126	1
PISTON-COMP-BRAKE (Ref # 43020)	43020-1051	1
HOLDER-BRAKE,REAR CALIPER (Ref # 43034)	43034-1052	1
CALIPER-ASSY,RR (Ref # 43041)	43041-1178	1
HOLDER-COMP-CALIPER,FR,LH (Ref # 43044)	43044-1035	1
RING,PISTON SEAL (Ref # 43049)	43049-002	1
PACKING,PISTON (Ref # 43049A)	43049-1028	1
BREATHER (Ref # 43056)	43056-003	1
CAP-BREATHER (Ref # 43057)	43057-003	1
PAD-ASSY-BRAKE (Ref # 43082)	43082-1029	1
BOOT,CALIPER (Ref # 49006)	49006-1094	1
BOOT,CALIPER (Ref # 49006A)	49006-1095	1
BOLT,DISC PLATE,8X30 (Ref # 92001)	92001-1951	7
SPRING,PAD (Ref # 92081)	92081-1525	1
SPRING,PAD STOPPER (Ref # 92081A)	92081-1661	2
BOLT-FLANGED,10X16 (Ref # 130)	130G1016	2