

# 1988 Voyager PARTS DIAGRAM

Taillight(s)

F2720-0169

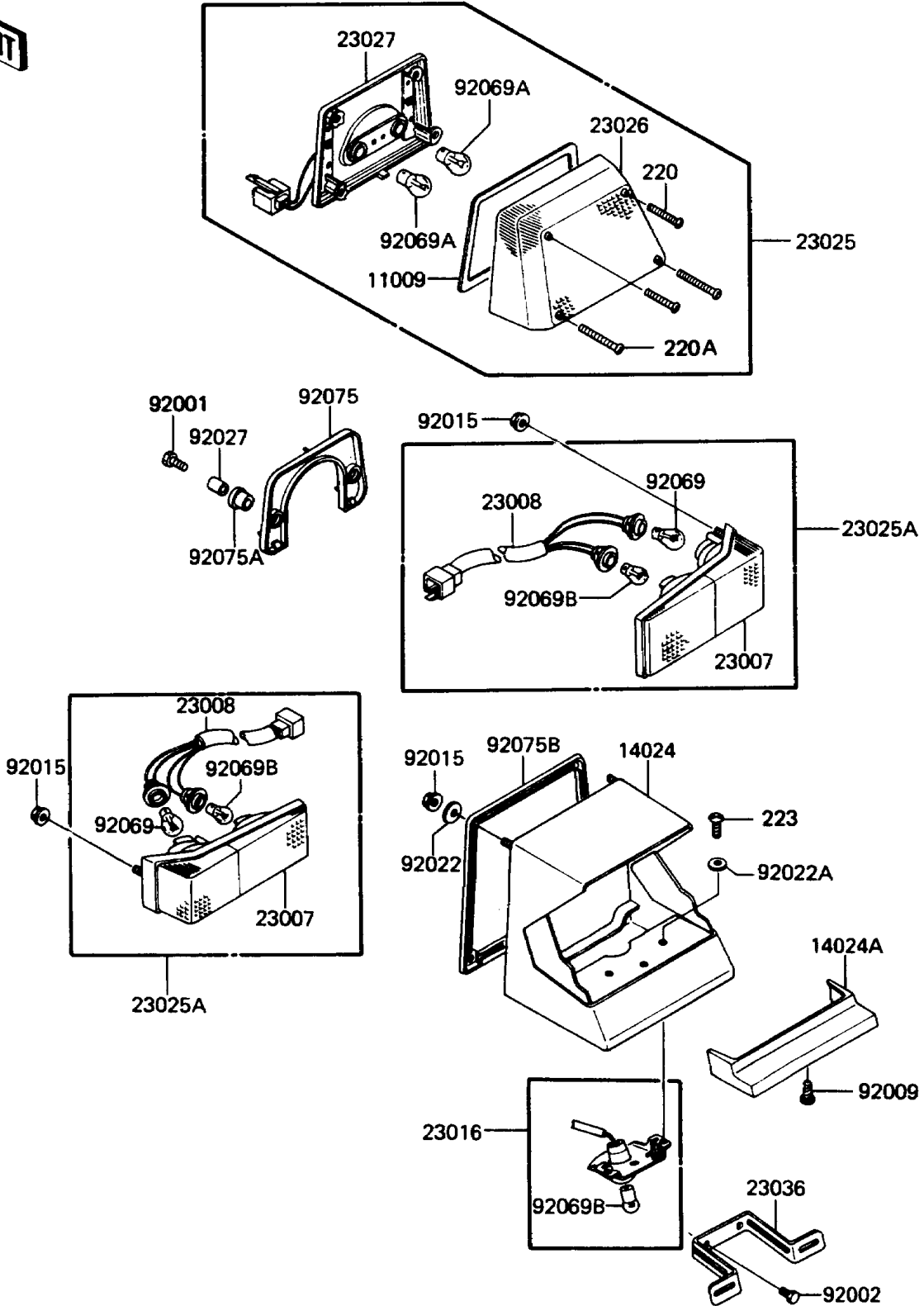

# 1988 Voyager PARTS LIST

## Taillight(s)

ITEM NAME	PART NUMBER	QUANTITY
GASKET,TAIL LAMP LENS (Ref # 11009)	11009-1098	1
COVER,TAIL LAMP,UPP (Ref # 14024)	14025-1669	1
COVER,TAIL LAMP,LWR (Ref # 14024A)	14025-1670	1
LENS-COMP,TAIL&SIGNAL LAMP (Ref # 23007)	23007-1101	2
SOCKET-ASSY,TAIL&SIGNAL LAMP (Ref # 23008)	23008-1203	2
LAMP-ASSY,LICENSE PLATE (Ref # 23016)	23016-1024	1
LAMP-TAIL,& STOP (Ref # 23025)	23025-1049	1
LAMP-TAIL,& TURN SIGNAL (Ref # 23025A)	23025-1050	2
LENS,TAIL LAMP (Ref # 23026)	23026-1055	1
BODY-COMP-TAIL LAMP (Ref # 23027)	23027-1054	1
BRACKET-TAIL LAMP (Ref # 23036)	23036-1054	1
BOLT,6X30 (Ref # 92001)	92001-1776	2
BOLT,6X14 (Ref # 92002)	92002-1260	2
SCREW,TAPPING,4X14 (Ref # 92009)	92008-010	1
NUT,FLANGED,5MM (Ref # 92015)	92015-1259	8
WASHER,5.5X20X1.2 (Ref # 92022)	92022-104	4
WASHER,4X12X1 (Ref # 92022A)	92022-1245	2
COLLAR,6.8X10X17.6 (Ref # 92027)	92027-1316	2
BULB,12V 32CP(23W) (Ref # 92069)	92069-055	2
BULB,12V 27/8W (Ref # 92069A)	92069-059	2
BULB,12V 8W (Ref # 92069B)	92069-1012	3
DAMPER,TAIL LAMP (Ref # 92075)	92075-1111	1
DAMPER,TAIL LAMP (Ref # 92075A)	92075-1367	2
DAMPER,TAIL LAMP COVER (Ref # 92075B)	92075-1471	1
SCREW-PAN-CROS (Ref # 220)	220B0445	2
SCREW-PAN-CROS (Ref # 220A)	220B0460	2
SCREW-PAN-WS-CROS (Ref # 223)	223B0412	2