

# 1988 Voyager PARTS DIAGRAM

Other

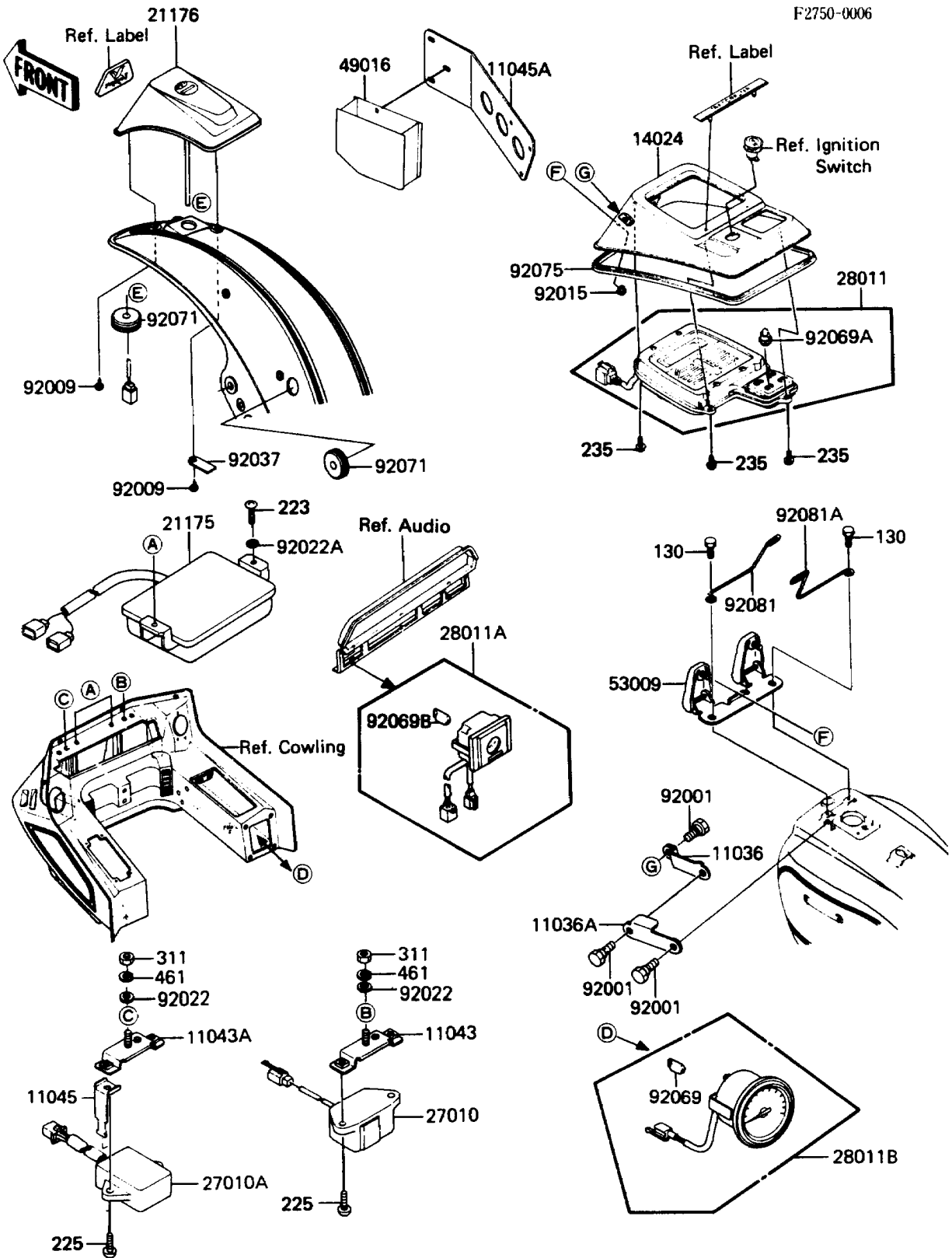

# 1988 Voyager PARTS LIST

Other

ITEM NAME	PART NUMBER	QUANTITY
BRACKET-A,STOPPER (Ref # 11036)	11036-1950	1
BRACKET-A,STOPPER (Ref # 11036A)	11036-1951	1
BRACKET (Ref # 11043)	11043-1253	1
BRACKET (Ref # 11043A)	11043-1254	1
BRACKET,CRUISE RELAY (Ref # 11045)	11045-1984	1
BRACKET,AUTO CRUISE (Ref # 11045A)	11045-1996	1
COVER,DRIVE COMPUTER (Ref # 14024)	14025-1641	1
CONTROL UNIT-ELECTRONIC (Ref # 21175)	21175-1009	1
SENSOR,QUARTER (Ref # 21176)	21176-1005	1
SWITCH,RESERV LIGHTING (Ref # 27010)	27010-1066	1
SWITCH,TURN SIGNAL OPERATION (Ref # 27010A)	27010-1153	1
METER,DRIVE COMPUTER (Ref # 28011)	28011-1037	1
METER,COMPASS (Ref # 28011A)	28011-1038	1
METER,AIR SUSPENSION (Ref # 28011B)	28011-1039	1
COVER-SEAL,AUTO CRUISE (Ref # 49016)	49016-1133	1
HINGE,DRIVE COMPUTER COVER (Ref # 53009)	53009-1037	1
BOLT,STOPPER (Ref # 92001)	92001-1815	3
SCREW,4X16,BLACK (Ref # 92009)	92009-1158	3
NUT,FLANGED,5MM (Ref # 92015)	92015-1259	2
WASHER,6.5X20X1.6,BLACK (Ref # 92022)	92022-1346	2
WASHER,5.2X16X1.2 (Ref # 92022A)	92022-263	2
CLAMP,SENSOR LEAD (Ref # 92037)	92037-1490	1
BULB,12V 3.4W (Ref # 92069)	92069-1007	1
BULB,12V 1.4W (Ref # 92069A)	92069-1056	3
BULB,12V 1.7W (Ref # 92069B)	92069-1059	1
GROMMET,SENSOR LEAD (Ref # 92071)	92071-1058	2
DAMPER,COVER (Ref # 92075)	92075-1460	1
SPRING,LH (Ref # 92081)	92081-1546	1
SPRING,RH (Ref # 92081A)	92081-1547	1

# 1988 Voyager PARTS LIST

Other

ITEM NAME	PART NUMBER	QUANTITY
BOLT-FLANGED,5X12 (Ref # 130)	130B0512	2
SCREW-PAN-WS-CROS,5X20 (Ref # 223)	223B0520	2
SCREW-PAN-WSP-CROS (Ref # 225)	225B0620	4
SCREW-PAN-WP-CROS (Ref # 235)	235B0514	4
NUT-HEX,6MM,BLACK (Ref # 311)	311C0600	2
WASHER-SPRING,6MM,BLACK (Ref # 461)	461K0600	2