

1988 Voyager PARTS DIAGRAM

Other

F2750B-0008

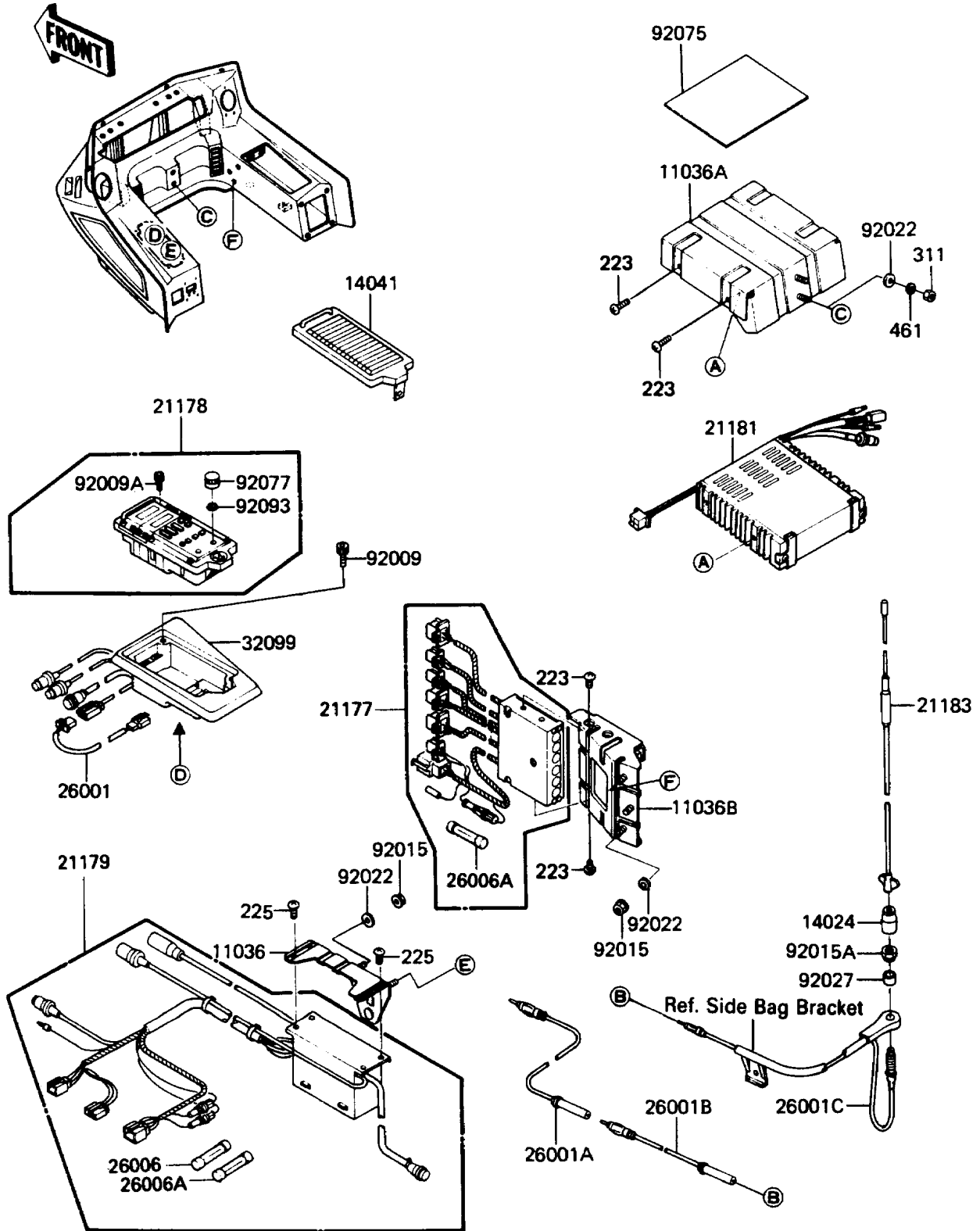

1988 Voyager PARTS LIST

Other

ITEM NAME	PART NUMBER	QUANTITY
BRACKET-A,RADIO (Ref # 11036)	11036-1955	1
BRACKET-A,AMPLIFIER (Ref # 11036A)	11036-1956	1
BRACKET-A,CONTROLLER (Ref # 11036B)	11036-1957	1
COVER,ANTENNA (Ref # 14024)	14024-1607	1
COVER-COMP,CONTROL SWITCH (Ref # 14041)	14041-1023	1
CONTROLLER,MIXING (Ref # 21177)	21177-1001	1
CONTROL-SWITCH (Ref # 21178)	21178-1051	1
RADIO-TUNER (Ref # 21179)	21179-1001	1
AMPLIFIER (Ref # 21181)	21181-1055	1
ANTENNA,ROD (Ref # 21183)	21183-1051	1
HARNESS,CONTROL SWITCH (Ref # 26001)	26001-1563	1
HARNESS,ANTENNA (Ref # 26001A)	26001-1564	1
HARNESS,ANTENNA (Ref # 26001B)	26001-1565	1
HARNESS,ANTENNA (Ref # 26001C)	26001-1566	1
FUSE,2A,L=30 (Ref # 26006)	26006-1001	1
FUSE,1A,L=30 (Ref # 26006A)	26006-1055	2
CASE,CONTROL SWITCH (Ref # 32099)	32099-1053	1
SCREW,SOCKET,5MM (Ref # 92009)	92009-1267	4
SCREW,SOCKET,5X8 (Ref # 92009A)	92009-1268	12
NUT,LOCK 6MM (Ref # 92015)	92015-1262	6
NUT,ANTENNA (Ref # 92015A)	92015-1313	1
WASHER,6.5X20X1.6,BLACK (Ref # 92022)	92022-1346	8
COLLAR,ANTENNA (Ref # 92027)	92027-1681	1
DAMPER (Ref # 92075)	92075-1076	1
KNOB,CASSETTE DECK (Ref # 92077)	92077-1053	2
SEAL,CASSETTE DECK (Ref # 92093)	92093-1155	2
SCREW-PAN-WS-CROS (Ref # 223)	223B0510	8
SCREW-PAN-WSP-CROS (Ref # 225)	225B0410	4
NUT-HEX,6MM,BLACK (Ref # 311)	311C0600	2

1988 Voyager PARTS LIST

Other

ITEM NAME	PART NUMBER	QUANTITY
WASHER-SPRING,6MM,BLACK (Ref # 461)	461K0600	2