

2023 Ninja® 400 ABS PARTS DIAGRAM

Crankshaft

E1321

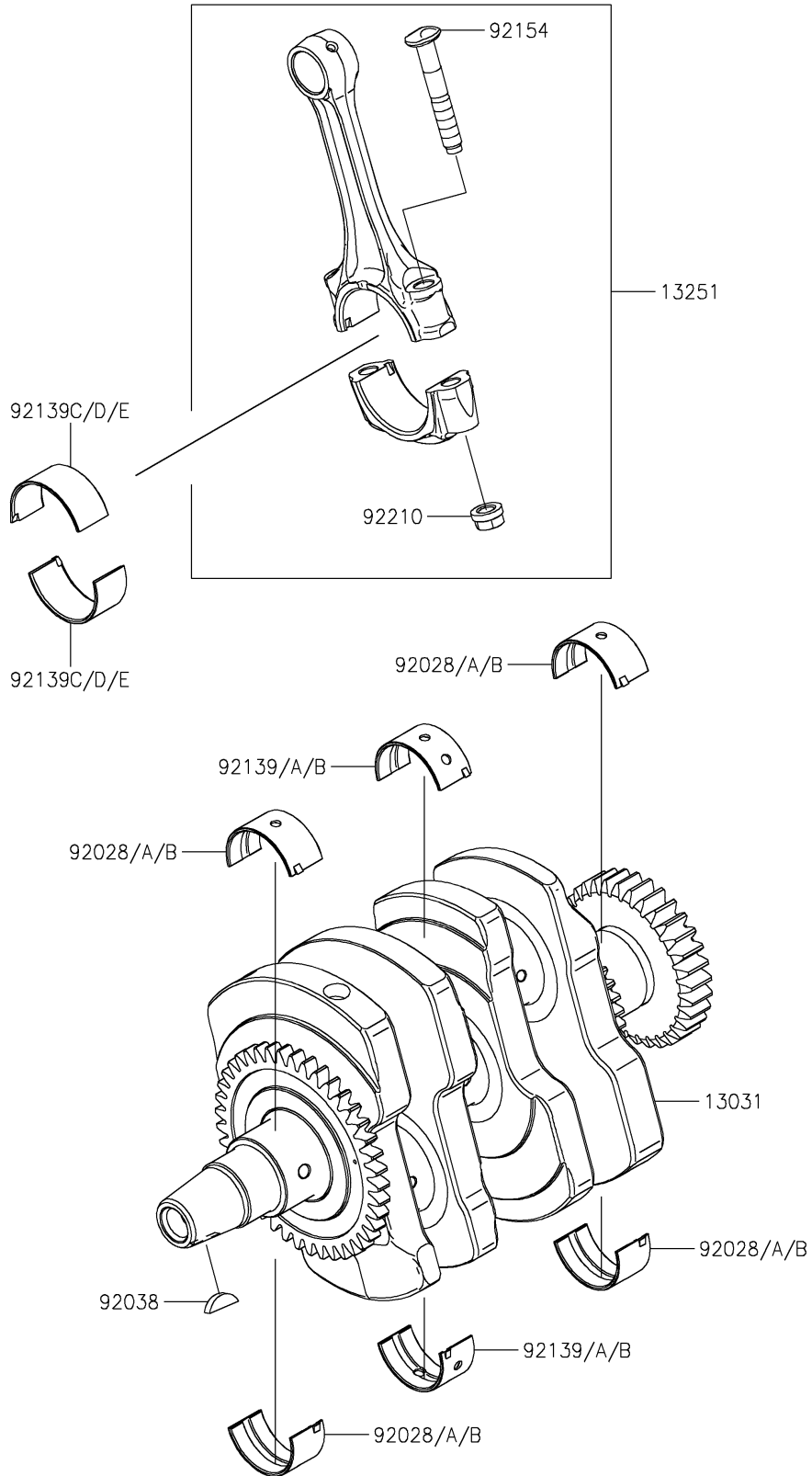

2023 Ninja® 400 ABS PARTS LIST

Crankshaft

ITEM NAME	PART NUMBER	QUANTITY
-----------	-------------	----------