

# 2023 Ninja® 400 ABS PARTS DIAGRAM

Rear Fender(s)

F2172

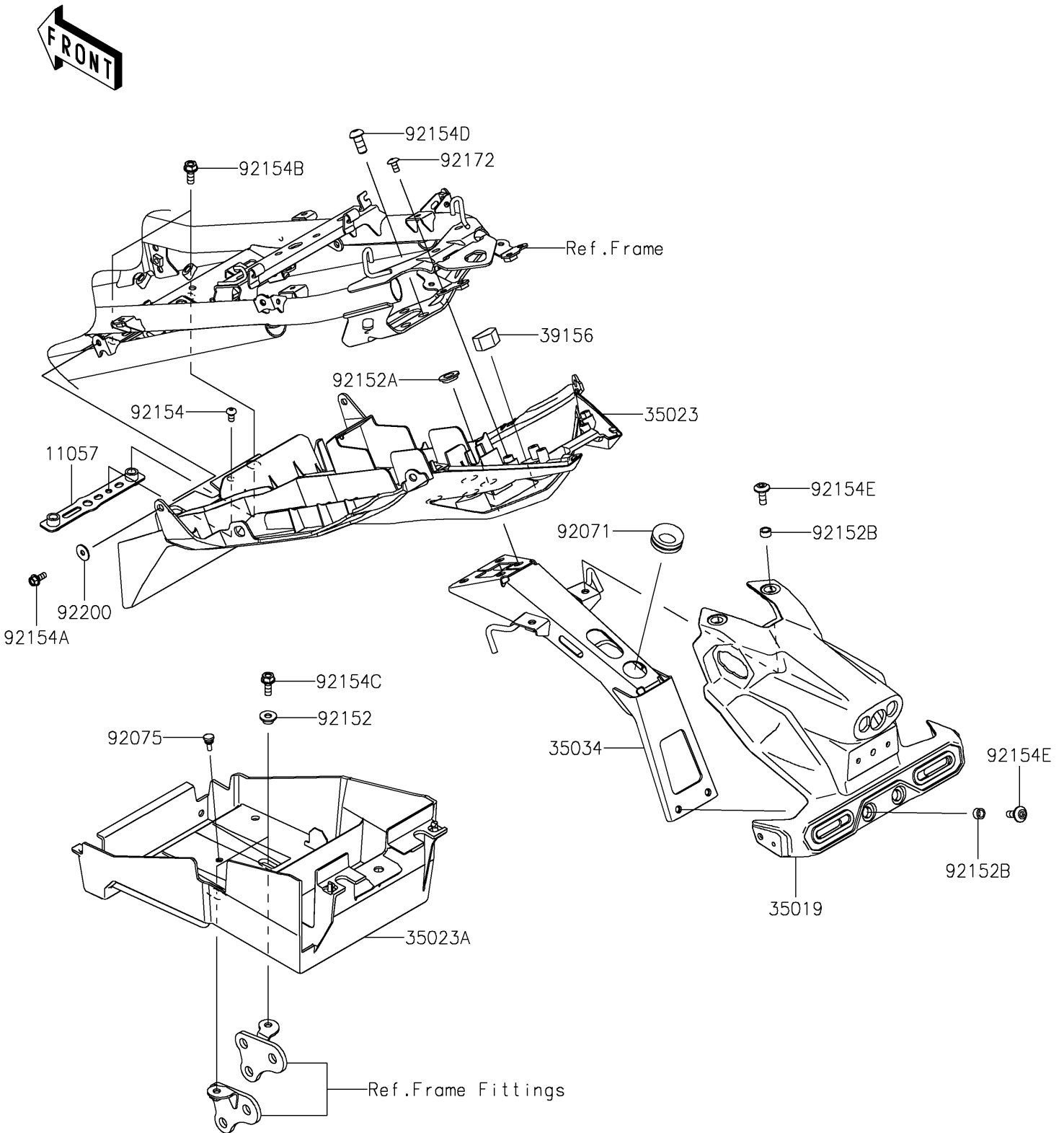

# 2023 Ninja® 400 ABS PARTS LIST

Rear Fender(s)

ITEM NAME	PART NUMBER	QUANTITY
-----------	-------------	----------