

2021 MULE PRO-MX™ EPS LE PARTS DIAGRAM

Battery

F2761

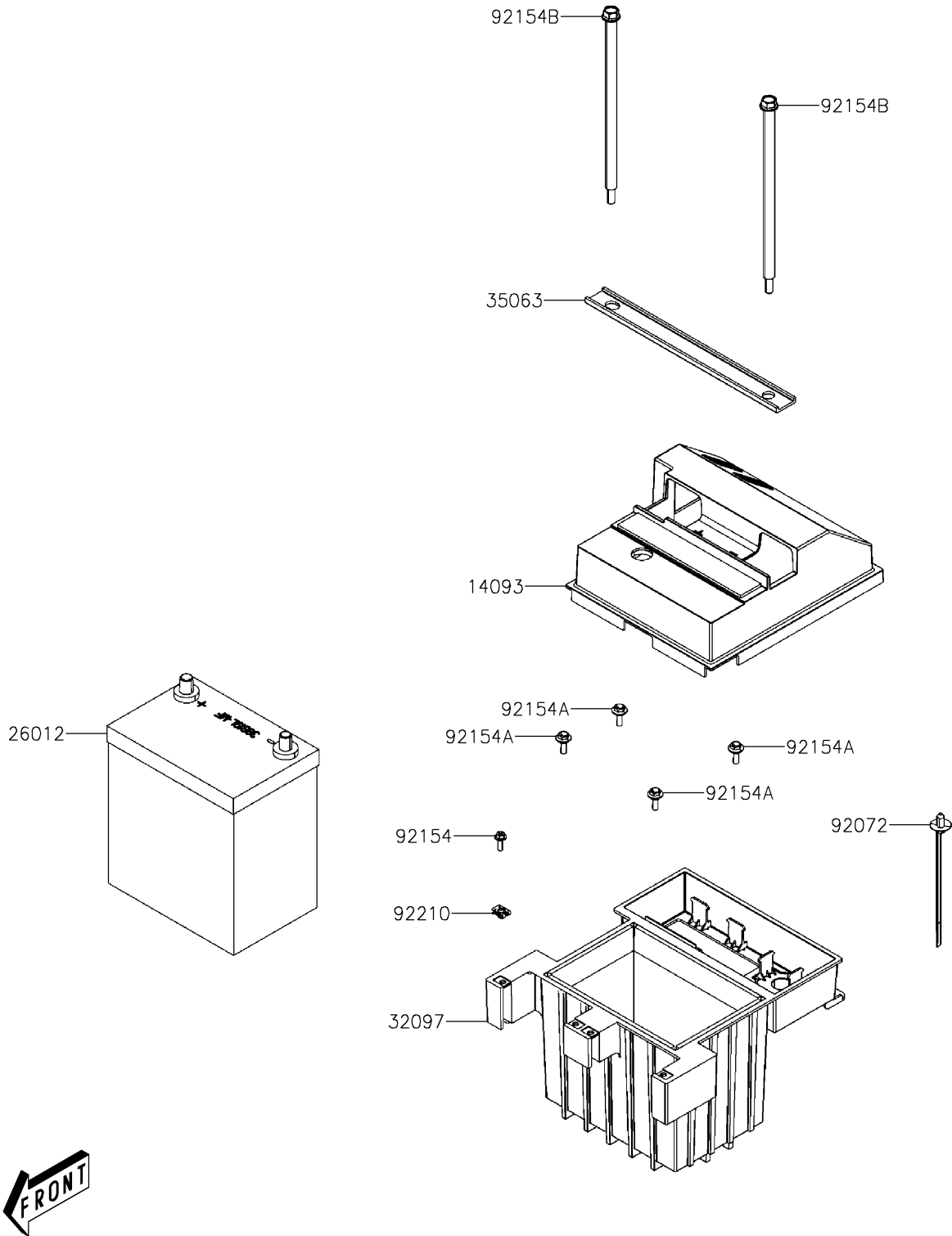

2021 MULE PRO-MX™ EPS LE PARTS LIST

Battery

| ITEM NAME | PART NUMBER | QUANTITY |
|----------------------------------|-------------|----------|
| COVER,BATTERY (Ref # 14093) | 14093-Y009 | 1 |
| BATTERY,38B19L-MF (Ref # 26012) | 26012-Y006 | 1 |
| CASE-BATTERY (Ref # 32097) | 32097-Y002 | 1 |
| STAY,BATTERY BAR (Ref # 35063) | 35063-Y041 | 1 |
| BAND (Ref # 92072) | 92072-Y020 | 5 |
| BOLT,5X16 (Ref # 92154) | 92154-Y085 | 4 |
| BOLT,6X18 (Ref # 92154A) | 92154-Y177 | 4 |
| BOLT,FLANGE,8X235 (Ref # 92154B) | 92154-Y201 | 2 |
| NUT,5MM (Ref # 92210) | 92210-Y016 | 4 |