

2011 KX™ 85 PARTS DIAGRAM

Crankshaft/Piston(s)

E1320

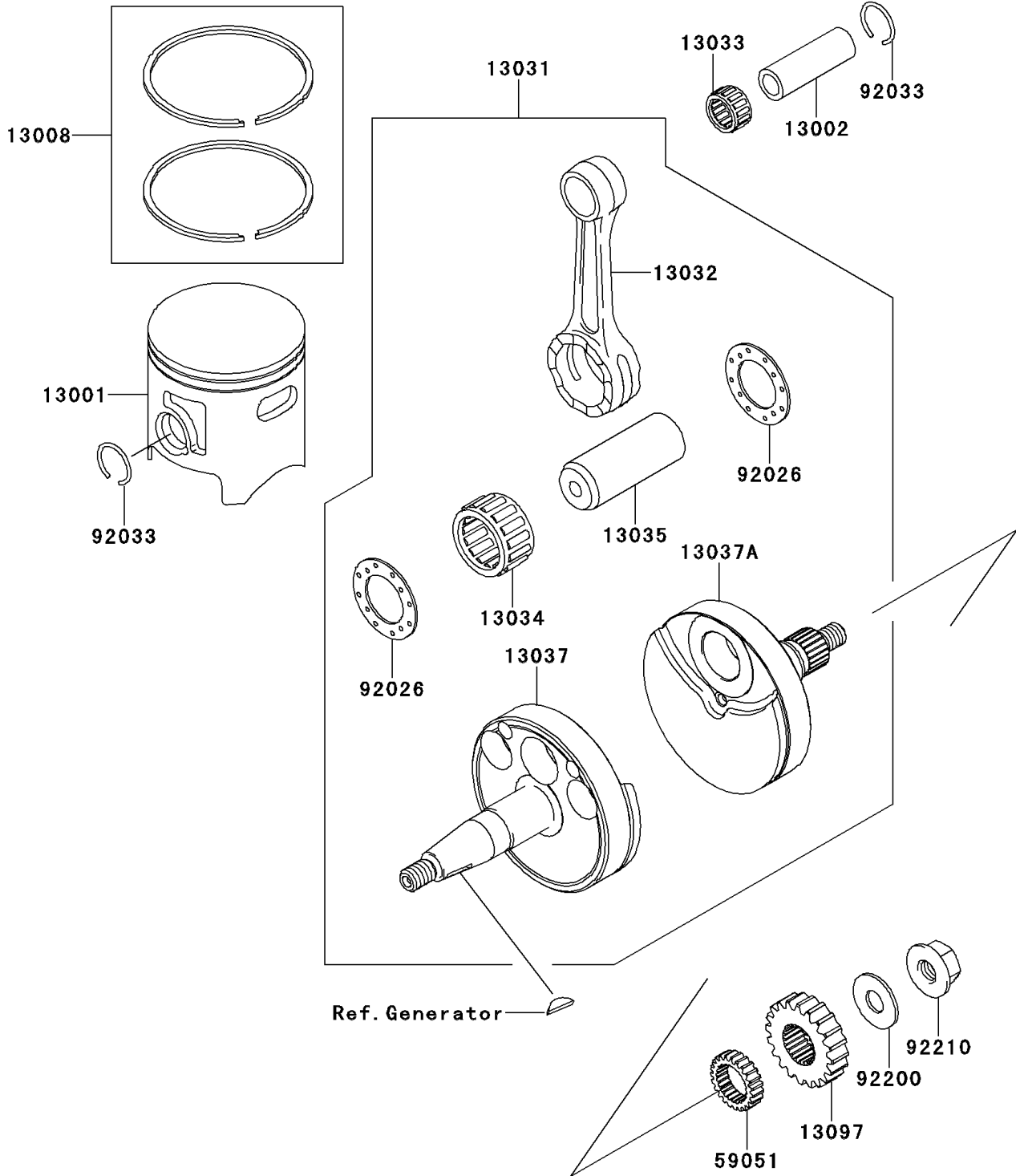

2011 KX™ 85 PARTS LIST

Crankshaft/Piston(s)

ITEM NAME	PART NUMBER	QUANTITY
PISTON-ENGINE,B (Ref # 13001)	13001-0006	1
PIN-PISTON (Ref # 13002)	13002-1079	1
RING-SET-PISTON (Ref # 13008)	13008-1200	1
CRANKSHAFT-COMP (Ref # 13031)	13031-0040	1
ROD-CONNECTING (Ref # 13032)	13032-1230	1
BEARING-SMALL END (Ref # 13033)	13033-1060	1
BEARING-BIG END,SKTZ 222916EGS (Ref # 13034)	13034-0013	1
PIN-CRANK (Ref # 13035)	13035-1054	1
CRANKSHAFT,LH (Ref # 13037)	13037-0050	1
CRANKSHAFT,RH (Ref # 13037A)	13037-0051	1
GEAR-PRIMARY SPUR,20T (Ref # 13097)	13097-1148	1
GEAR-SPUR,PUMP,23T (Ref # 59051)	59051-1146	1
SPACER,22.2X37X1.0 (Ref # 92026)	92026-1136	2
RING-SNAP (Ref # 92033)	92033-0005	2
WASHER,10.2X25X1.5 (Ref # 92200)	92200-0213	1
NUT,FLANGED,M10XL1.25 (Ref # 92210)	92210-0215	1