

# 2022 KX™ 250X PARTS DIAGRAM

Valve(s)

E1210

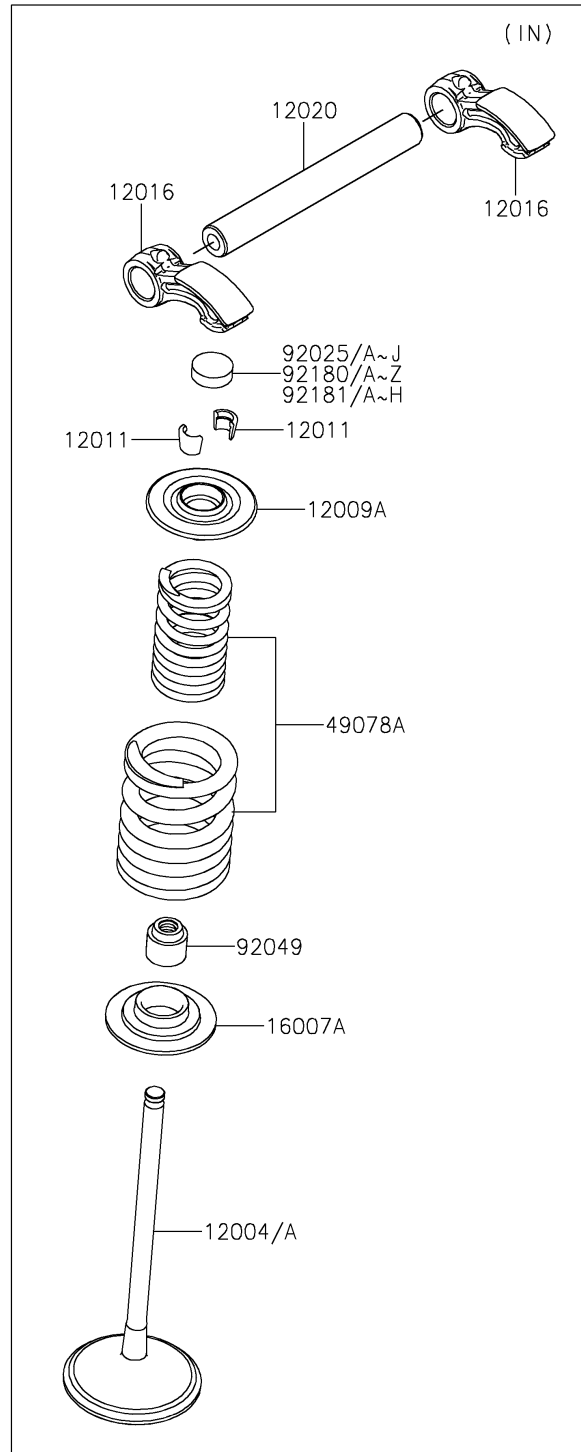
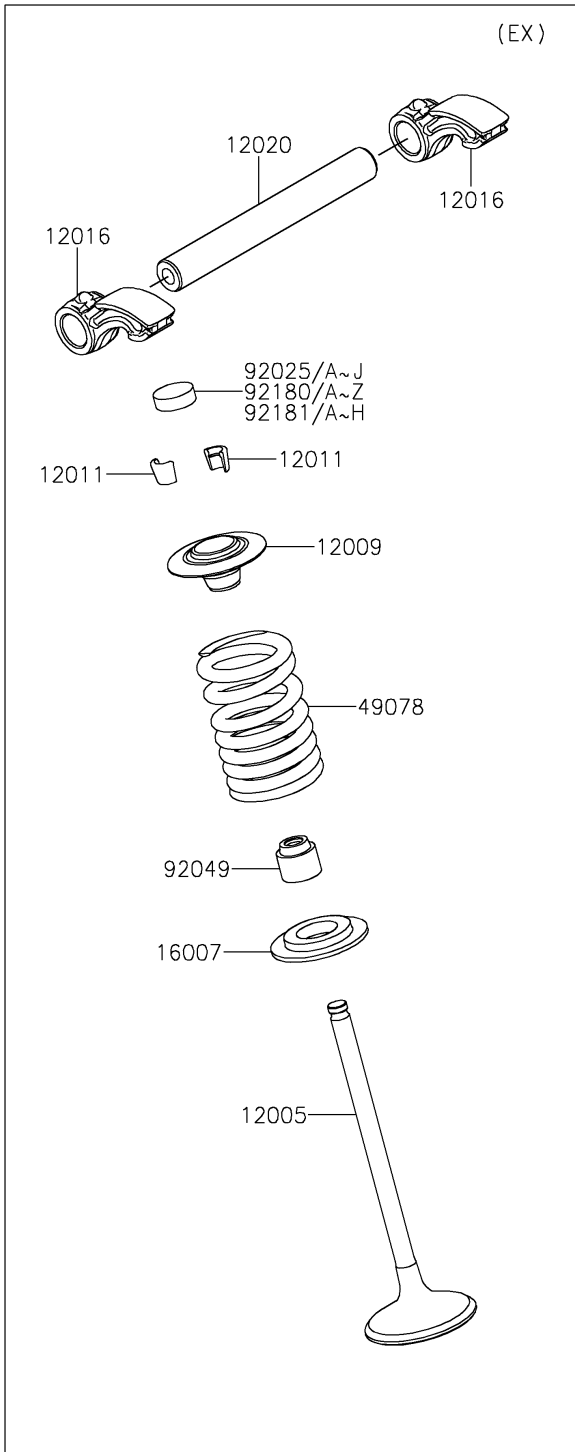

## 2022 KX™ 250X PARTS LIST

Valve(s)

ITEM NAME	PART NUMBER	QUANTITY
VALVE-INTAKE (Ref # 12004)	12004-0768	2
VALVE-EXHAUST (Ref # 12005)	12005-0794	2
RETAINER-VALVE SPRING (Ref # 12009)	12009-0040	2
RETAINER-VALVE SPRING (Ref # 12009A)	12009-0047	2
COLLET (Ref # 12011)	12011-1053	8
ARM-ROCKER (Ref # 12016)	12016-0726	4
SHAFT-ROCKER,EXHAUST (Ref # 12020)	12020-0025	2
SEAT-SPRING (Ref # 16007)	16007-0029	2
SEAT-SPRING (Ref # 16007A)	16007-0760	2
SPRING-ENGINE VALVE (Ref # 49078)	49078-0729	2
SPRING-ENGINE VALVE (Ref # 49078A)	49078-0791	2
SHIM,T=2.50 (Ref # 92025)	92025-1880	AR
SHIM,T=2.55 (Ref # 92025A)	92025-1881	AR
SHIM,T=2.60 (Ref # 92025B)	92025-1882	AR
SHIM,T=2.65 (Ref # 92025C)	92025-1883	AR
SHIM,T=2.70 (Ref # 92025D)	92025-1884	AR
SHIM,T=2.75 (Ref # 92025E)	92025-1885	AR
SHIM,T=2.80 (Ref # 92025F)	92025-1886	AR
SHIM,T=2.85 (Ref # 92025G)	92025-1887	AR
SHIM,T=2.90 (Ref # 92025H)	92025-1888	AR
SHIM,T=2.95 (Ref # 92025I)	92025-1889	AR
SHIM,T=3.00 (Ref # 92025J)	92025-1890	4
SEAL-OIL,VSB 4.3 7.5 5.3 8.3 (Ref # 92049)	92049-1349	4
SHIM,T=2.825 (Ref # 92180)	92180-0216	AR
SHIM,T=2.875 (Ref # 92180A)	92180-0217	AR
SHIM,T=2.925 (Ref # 92180B)	92180-0218	AR
SHIM,T=2.975 (Ref # 92180C)	92180-0219	AR
SHIM,T=2.775 (Ref # 92180D)	92180-1196	AR
SHIM,T=3.025 (Ref # 92180E)	92180-1523	AR

## 2022 KX™ 250X PARTS LIST

Valve(s)

ITEM NAME	PART NUMBER	QUANTITY
SHIM,T=3.050 (Ref # 92180F)	92180-1524	AR
SHIM,T=3.075 (Ref # 92180G)	92180-1525	AR
SHIM,T=3.100 (Ref # 92180H)	92180-1526	AR
SHIM,T=3.125 (Ref # 92180I)	92180-1527	AR
SHIM,T=3.150 (Ref # 92180J)	92180-1528	AR
SHIM,T=3.175 (Ref # 92180K)	92180-1529	AR
SHIM,T=3.200 (Ref # 92180L)	92180-1530	AR
SHIM,T=3.225 (Ref # 92180M)	92180-1531	AR
SHIM,T=3.250 (Ref # 92180N)	92180-1532	AR
SHIM,T=3.300 (Ref # 92180O)	92180-1533	AR
SHIM,T=3.350 (Ref # 92180P)	92180-1534	AR
SHIM,T=3.400 (Ref # 92180Q)	92180-1535	AR
SHIM,T=3.450 (Ref # 92180R)	92180-1536	AR
SHIM,T=3.500 (Ref # 92180S)	92180-1537	AR
SHIM,T=2.8125 (Ref # 92180T)	92180-1566	AR
SHIM,T=2.8375 (Ref # 92180U)	92180-1567	AR
SHIM,T=2.8625 (Ref # 92180V)	92180-1569	AR
SHIM,T=2.8875 (Ref # 92180W)	92180-1570	AR
SHIM,T=2.9125 (Ref # 92180X)	92180-1572	AR
SHIM,T=2.9375 (Ref # 92180Y)	92180-1573	AR
SHIM,T=2.9625 (Ref # 92180Z)	92180-1575	AR
SHIM,T=2.9875 (Ref # 92181)	92180-1576	AR
SHIM,T=3.0125 (Ref # 92181A)	92180-1578	AR
SHIM,T=3.0375 (Ref # 92181B)	92180-1579	AR
SHIM,T=3.0625 (Ref # 92181C)	92180-1580	AR
SHIM,T=3.0875 (Ref # 92181D)	92180-1581	AR
SHIM,T=3.1125 (Ref # 92181E)	92180-1582	AR
SHIM,T=3.1375 (Ref # 92181F)	92180-1583	AR
SHIM,T=3.1625 (Ref # 92181G)	92180-1584	AR

## 2022 KX™ 250X PARTS LIST

Valve(s)

ITEM NAME	PART NUMBER	QUANTITY
SHIM,T=3.1875 (Ref # 92181H)	92180-1585	AR