

2022 KX™ 250X PARTS DIAGRAM

Handlebar

F2310

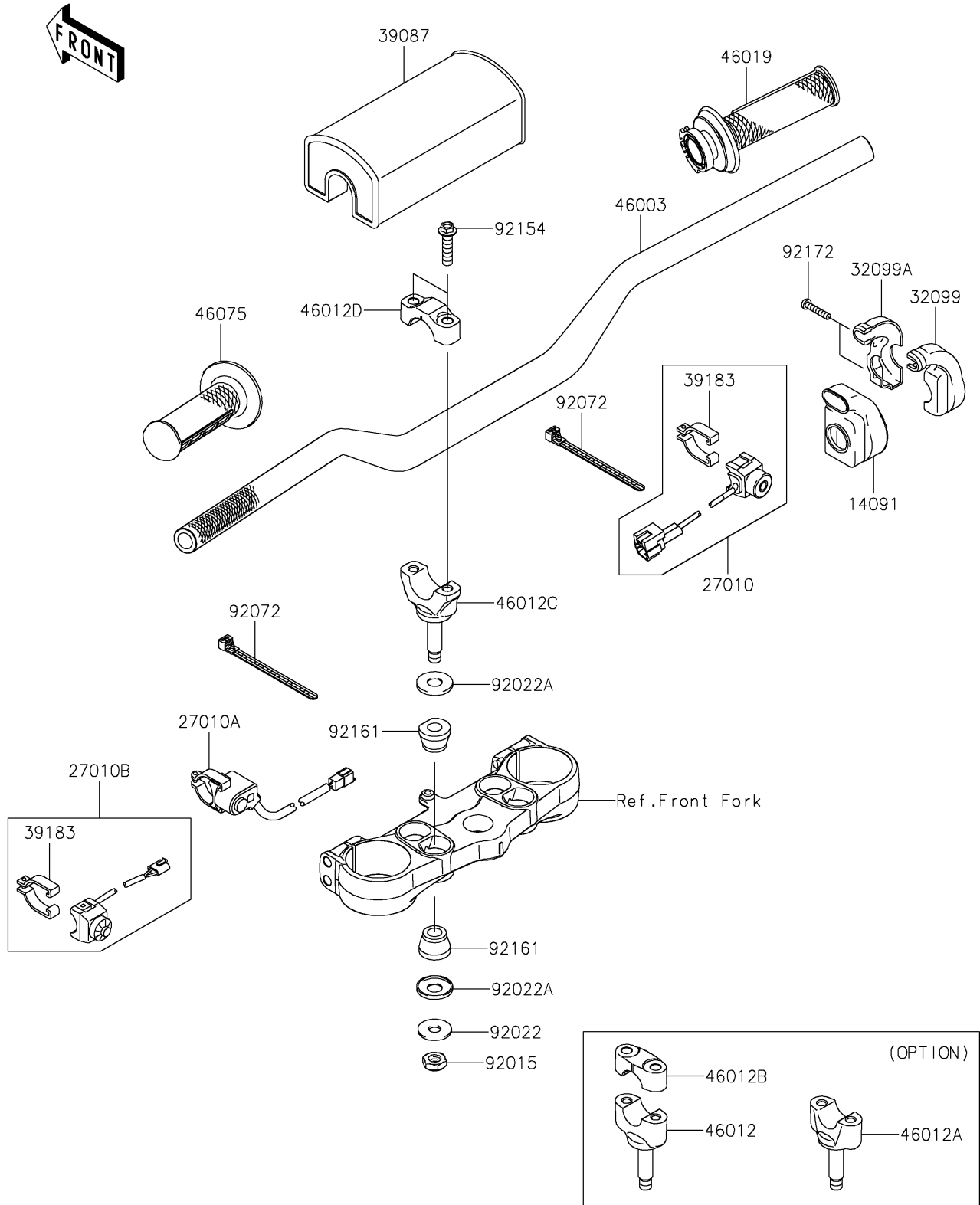

2022 KX™ 250X PARTS LIST

Handlebar

ITEM NAME	PART NUMBER	QUANTITY
COVER,THROTTLE CASE (Ref # 14091)	14091-0182	1
SWITCH,STARTER (Ref # 27010)	27010-0907	1
SWITCH,LAUNCH MODE (Ref # 27010A)	27010-0908	1
SWITCH,ENGINE STOP (Ref # 27010B)	27010-0909	1
CASE,THROTTLE,RR (Ref # 32099)	32099-0002	1
CASE,THROTTLE,FR (Ref # 32099A)	32099-0003	1
PAD-HANDLE (Ref # 39087)	39087-0015	1
BAND-ASSY,SWITCH (Ref # 39183)	39183-1059	2
HANDLE,RENTHAL,FATBAR,839 (Ref # 46003)	46003-0780	1
HOLDER-HANDLE,LWR,F.BLACK (Ref # 46012)	46012-0013-21	2
HOLDER-HANDLE,LWR,F.BLACK (Ref # 46012A)	46012-0048-21	2
HOLDER-HANDLE,UPP,F.BLACK (Ref # 46012B)	46012-0324-21	2
HOLDER-HANDLE,LWR,FAT BAR (Ref # 46012C)	46012-0417	2
HOLDER-HANDLE,UPP,FAT BAR (Ref # 46012D)	46012-0418	2
GRIP-ASSY,THROTTLE (Ref # 46019)	46019-0041	1
GRIP,LH (Ref # 46075)	46075-0072	1
NUT,LOCK,10MM (Ref # 92015)	92015-1962	2
WASHER,10.2X28X2 (Ref # 92022)	92022-1088	2
WASHER (Ref # 92022A)	92022-1737	4
BAND,L=140 (Ref # 92072)	92072-1293	2
BOLT,8X32 (Ref # 92154)	92154-2974	4
DAMPER,HANDLE HOLDER (Ref # 92161)	92161-0929	4
SCREW,5X20 (Ref # 92172)	92172-0069	2