

2020 MULE 4000 TRANS™ PARTS DIAGRAM

Flap

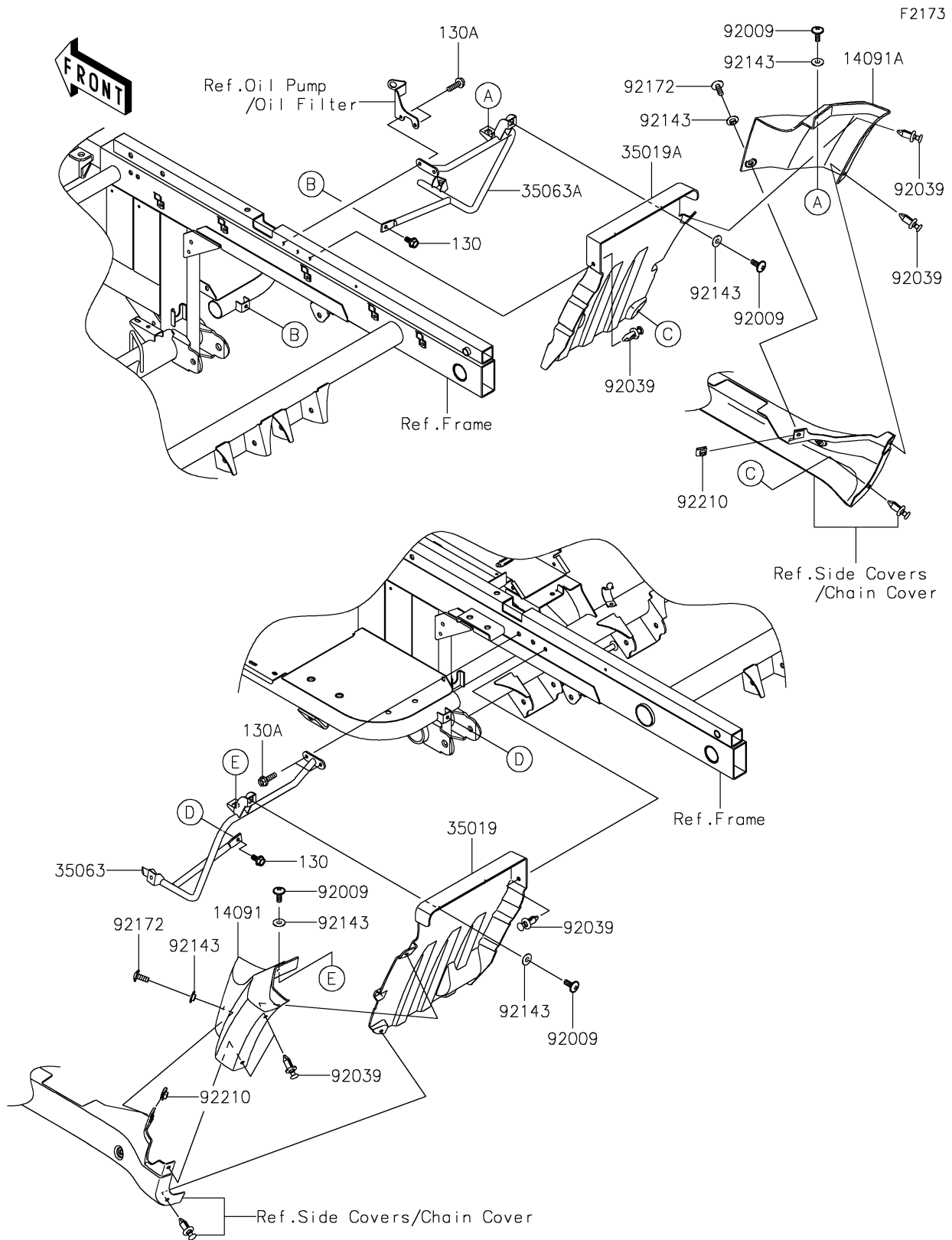

2020 MULE 4000 TRANS™ PARTS LIST

Flap

ITEM NAME	PART NUMBER	QUANTITY
COVER,REAR FENDER,LWR,LH,F.BLK (Ref # 14091)	14091-0819-6Z	1
COVER,REAR FENDER,LWR,RH,F.BLK (Ref # 14091A)	14091-0820-6Z	1
FLAP,RR,LH (Ref # 35019)	35019-0066	1
FLAP,RR,RH (Ref # 35019A)	35019-0067	1
STAY,RR,LH (Ref # 35063)	35063-0451	1
STAY,RR,RH (Ref # 35063A)	35063-0452	1
SCREW,6X16 (Ref # 92009)	92009-1621	4
RIVET (Ref # 92039)	92039-0776	6
COLLAR (Ref # 92143)	92143-1087	6
SCREW,TAPPING,6X20 (Ref # 92172)	92172-0488	2
NUT,LEAF SPRING,6MM (Ref # 92210)	92210-0624	2
BOLT-FLANGED,6X14 (Ref # 130)	130BA0614	2
BOLT-FLANGED,6X20 (Ref # 130A)	130BA0620	4