

2020 MULE™ 4010 4x4 PARTS DIAGRAM

Guards/Cab Frame

F2681

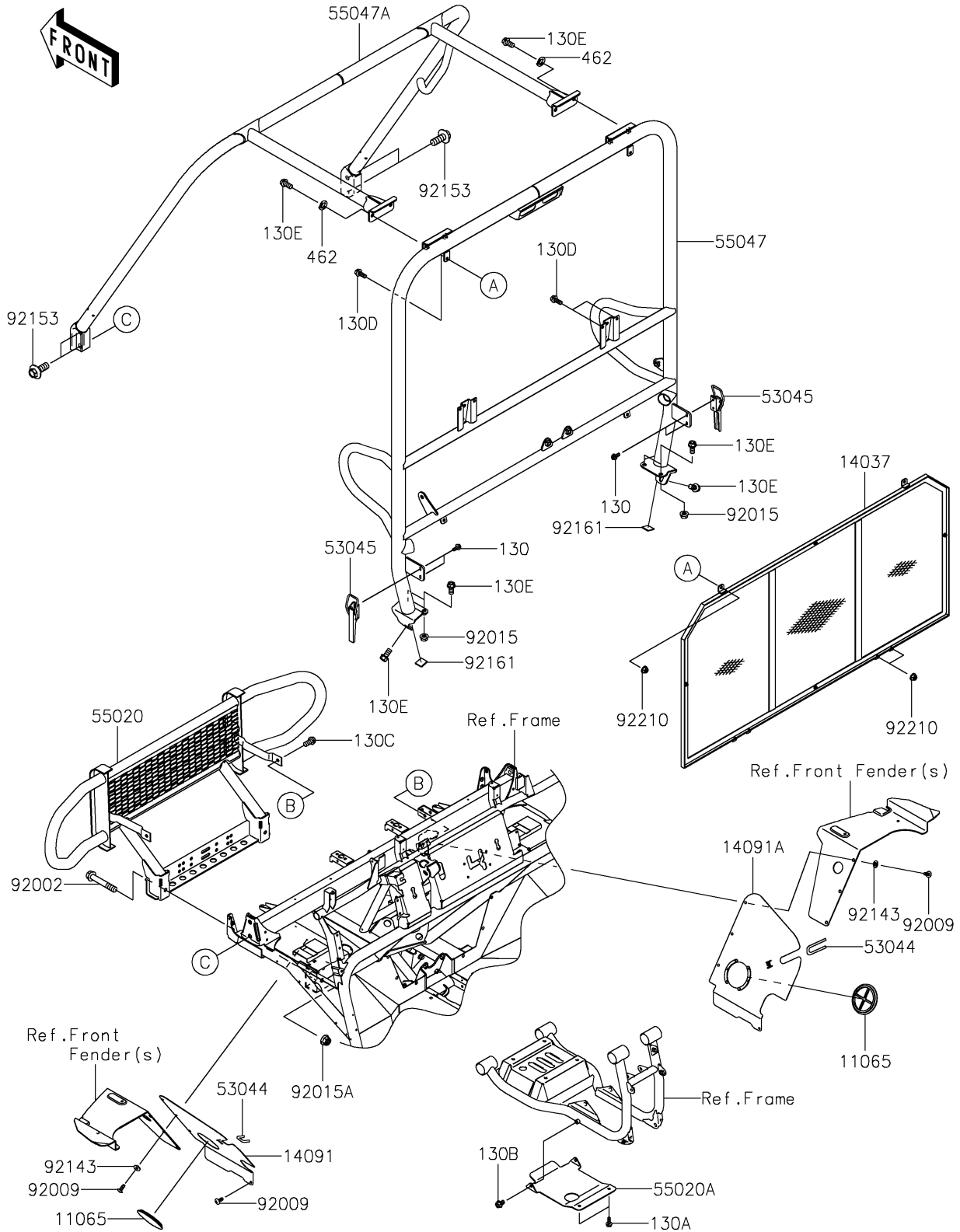

2020 MULE™ 4010 4x4 PARTS LIST

Guards/Cab Frame

ITEM NAME	PART NUMBER	QUANTITY
CAP,F.BLACK (Ref # 11065)	11065-1053-6Z	2
SCREEN,REAR GUARD,T.BLACK (Ref # 14037)	14037-0016-388	1
COVER,FR,LH (Ref # 14091)	14091-1758	1
COVER,FR,RH (Ref # 14091A)	14091-1759	1
TRIM (Ref # 53044)	53044-1137	2
HOOK-ASSY (Ref # 53045)	53045-1063	2
GUARD,FR (Ref # 55020)	55020-0876	1
GUARD,GEAR CASE (Ref # 55020A)	55020-7506	1
BAR-COMP,T.BLACK (Ref # 55047)	55047-0354-388	1
BAR-COMP,FR,T.BLACK (Ref # 55047A)	55047-7514-388	1
BOLT,FLANGED,12X75 (Ref # 92002)	92002-1661	2
SCREW,TAPPING,6X16 (Ref # 92009)	92009-1166	8
NUT,FLANGED,10MM (Ref # 92015)	92015-1428	4
NUT,LOCK,FLANGED,12MM (Ref # 92015A)	92015-1433	2
COLLAR (Ref # 92143)	92143-1087	6
BOLT,FLANGED,14X36 (Ref # 92153)	92153-1282	4
DAMPER (Ref # 92161)	92161-0020	2
NUT,FLANGED,LOCK,8MM (Ref # 92210)	92210-0005	6
BOLT-FLANGED,6X14 (Ref # 130)	130BA0614	4
BOLT-FLANGED,6X16 (Ref # 130A)	130BA0616	2
BOLT-FLANGED,8X12 (Ref # 130B)	130BA0812	2
BOLT-FLANGED,10X20 (Ref # 130C)	130BA1020	2
BOLT-FLANGED,8X20 (Ref # 130D)	130BB0820	6
BOLT-FLANGED,10X20 (Ref # 130E)	130BB1020	10
WASHER-SPRING,10MM (Ref # 462)	462DB1000	4