

2009 Mule 4010 4x4 PARTS DIAGRAM

Oil Pump/Oil Filter

E1710

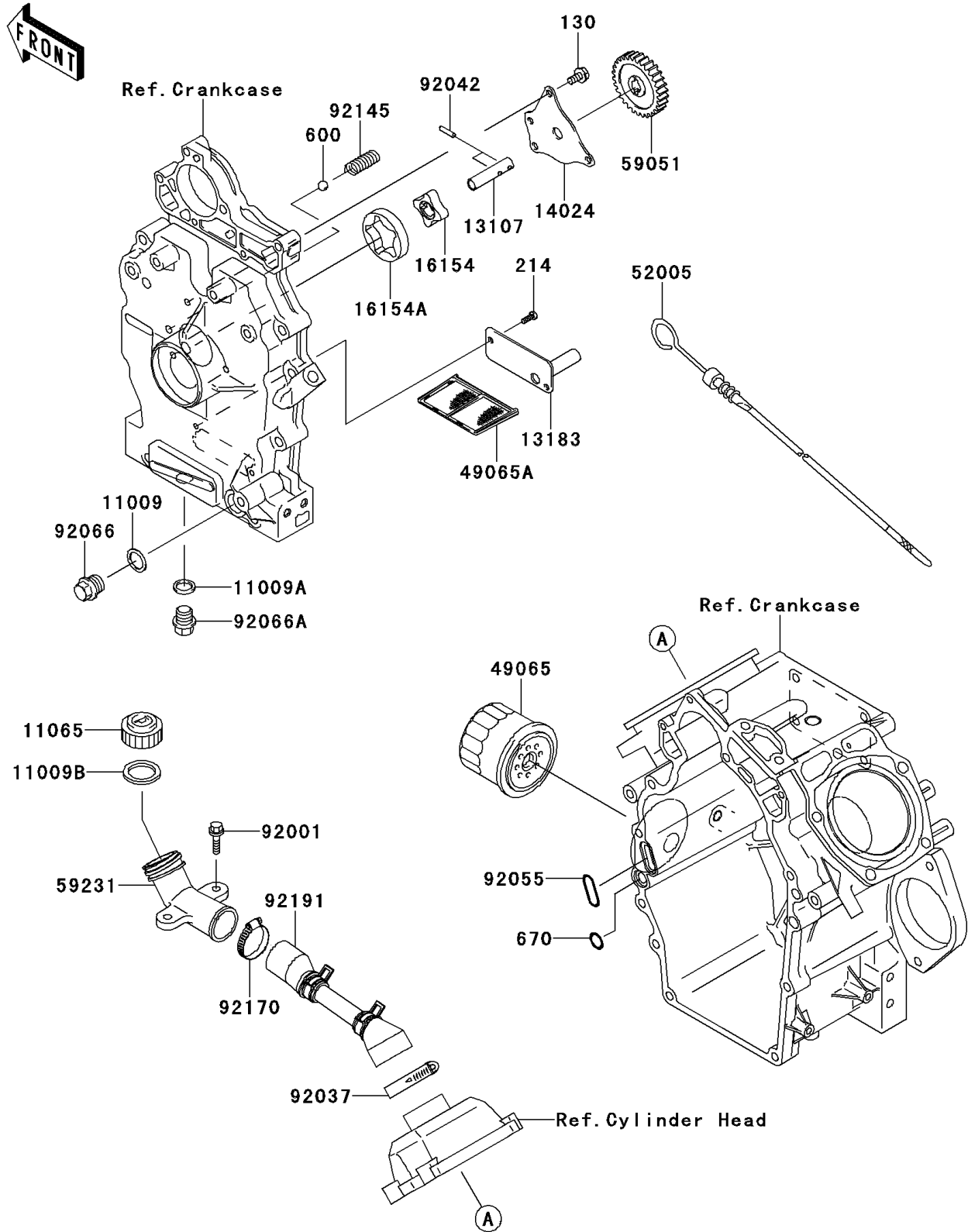

2009 Mule 4010 4x4 PARTS LIST

Oil Pump/Oil Filter

ITEM NAME	PART NUMBER	QUANTITY
GASKET,16.2X22X1 (Ref # 11009)	11009-1467	1
GASKET (Ref # 11009A)	11009-2175	1
GASKET,OIL GAUGE (Ref # 11009B)	11009-2346	1
CAP (Ref # 11065)	11065-1167	1
SHAFT,OIL PUMP (Ref # 13107)	13107-2296	1
PLATE (Ref # 13183)	13183-2419	1
COVER,OIL PUMP (Ref # 14024)	14024-2113	1
ROTOR-PUMP,IN (Ref # 16154)	16154-2053	1
ROTOR-PUMP,OUT (Ref # 16154A)	16154-2054	1
FILTER-OIL (Ref # 49065)	49065-2071	1
FILTER-OIL (Ref # 49065A)	49065-2072	1
GAUGE (Ref # 52005)	52005-2149	1
GEAR-SPUR (Ref # 59051)	59051-2114	1
FILLER (Ref # 59231)	59231-1106	1
BOLT,WP,6X20 (Ref # 92001)	92001-1460	2
CLAMP (Ref # 92037)	92037-506	1
PIN,DOWEL,4X15.8 (Ref # 92042)	92042-014	2
RING-O (Ref # 92055)	92055-2086	1
PLUG,16X11.5 (Ref # 92066)	92066-2251	1
PLUG,14X12 (Ref # 92066A)	92066-2253	1
SPRING (Ref # 92145)	92145-2132	1
CLAMP (Ref # 92170)	92170-1036	1
TUBE (Ref # 92191)	92191-1579	1
BOLT-FLANGED,6X12 (Ref # 130)	130AA0612	3
SCREW-PAN+-,5X12 (Ref # 214)	214AA0512	2
"BALL-STEEL,13/32",,2017-03-16 13:3 (Ref # 600)	600A1300	1
O RING,11MM (Ref # 670)	670B2011	1