

2013 Mule 4010 Trans4x4 PARTS DIAGRAM

Crankcase

E1411

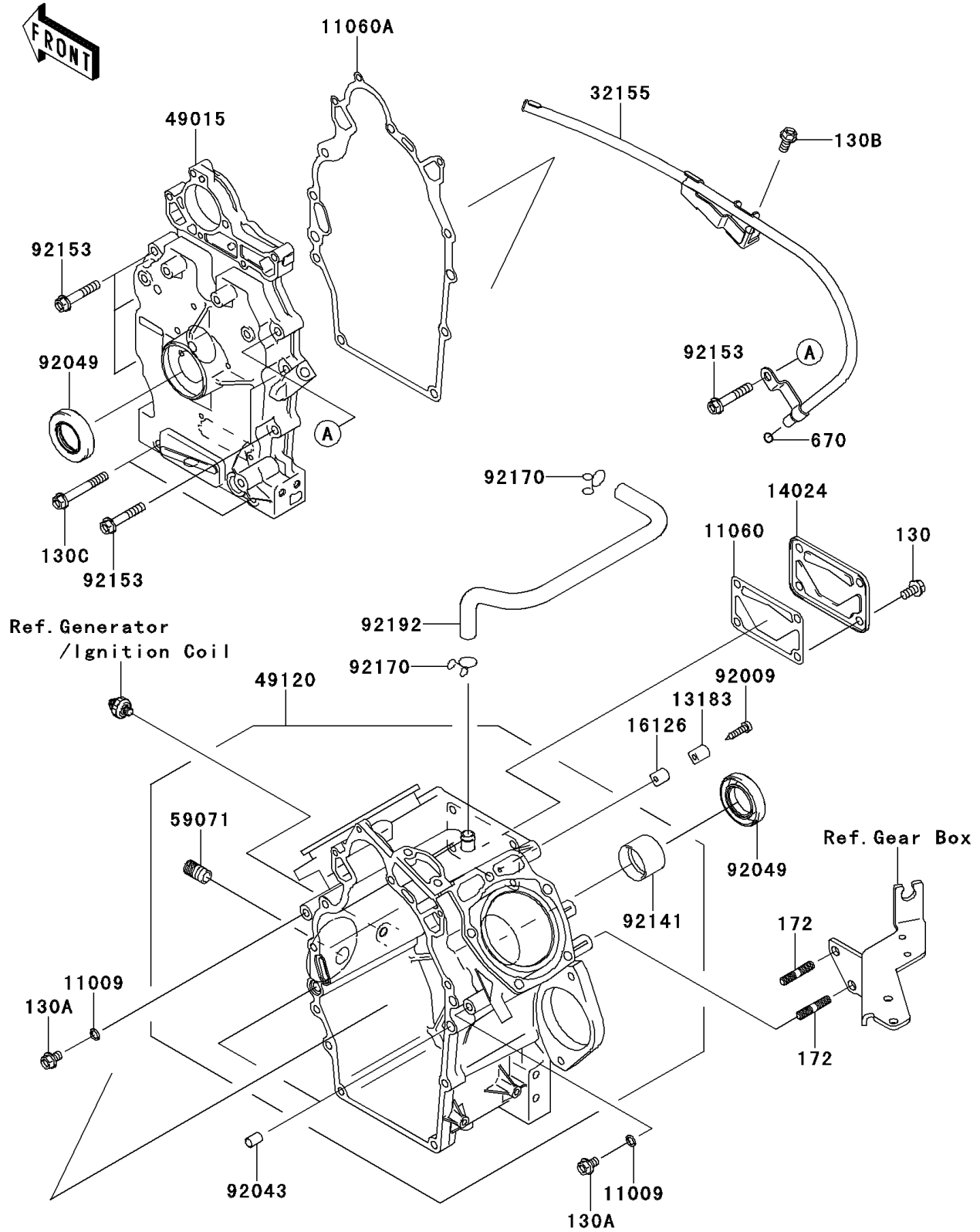

2013 Mule 4010 Trans4x4 PARTS LIST

Crankcase

ITEM NAME	PART NUMBER	QUANTITY
GASKET (Ref # 11009)	11009-3028	2
GASKET (Ref # 11060)	11060-2089	1
GASKET,CRANKCASE COVER (Ref # 11060A)	11060-2449	1
PLATE (Ref # 13183)	13183-2120	1
COVER (Ref # 14024)	14024-2292	1
VALVE (Ref # 16126)	16126-2146	1
PIPE,F.BLACK (Ref # 32155)	32155-2005-9H	1
COVER-CRANKCASE (Ref # 49015)	49015-6282	1
CRANKCASE-COMP (Ref # 49120)	49120-6201	1
JOINT (Ref # 59071)	59071-2079	1
SCREW (Ref # 92009)	92009-2308	1
PIN,DOWEL,10X14 (Ref # 92043)	92043-1037	2
SEAL-OIL (Ref # 92049)	92049-2112	2
BEARING-PLANE (Ref # 92141)	92141-2122	1
BOLT,FLANGED,8X45 (Ref # 92153)	92153-2130	6
CLAMP (Ref # 92170)	92170-2002	2
TUBE,BRETHHER (Ref # 92192)	92192-2140	1
BOLT-FLANGED,8X16 (Ref # 130)	130AA0816	4
BOLT-FLANGED,8X12 (Ref # 130A)	130AB0812	2
BOLT-FLANGED,8X16 (Ref # 130B)	130BA0816	1
BOLT-FLANGED,8X60 (Ref # 130C)	130CA0860	2
BOLT-STUD,8X25 (Ref # 172)	172BA0825	2
O RING,10MM (Ref # 670)	670B2010	1