

# 2014 MULE™ 4010 TRANS4x4® PARTS DIAGRAM

Front Suspension

F2152

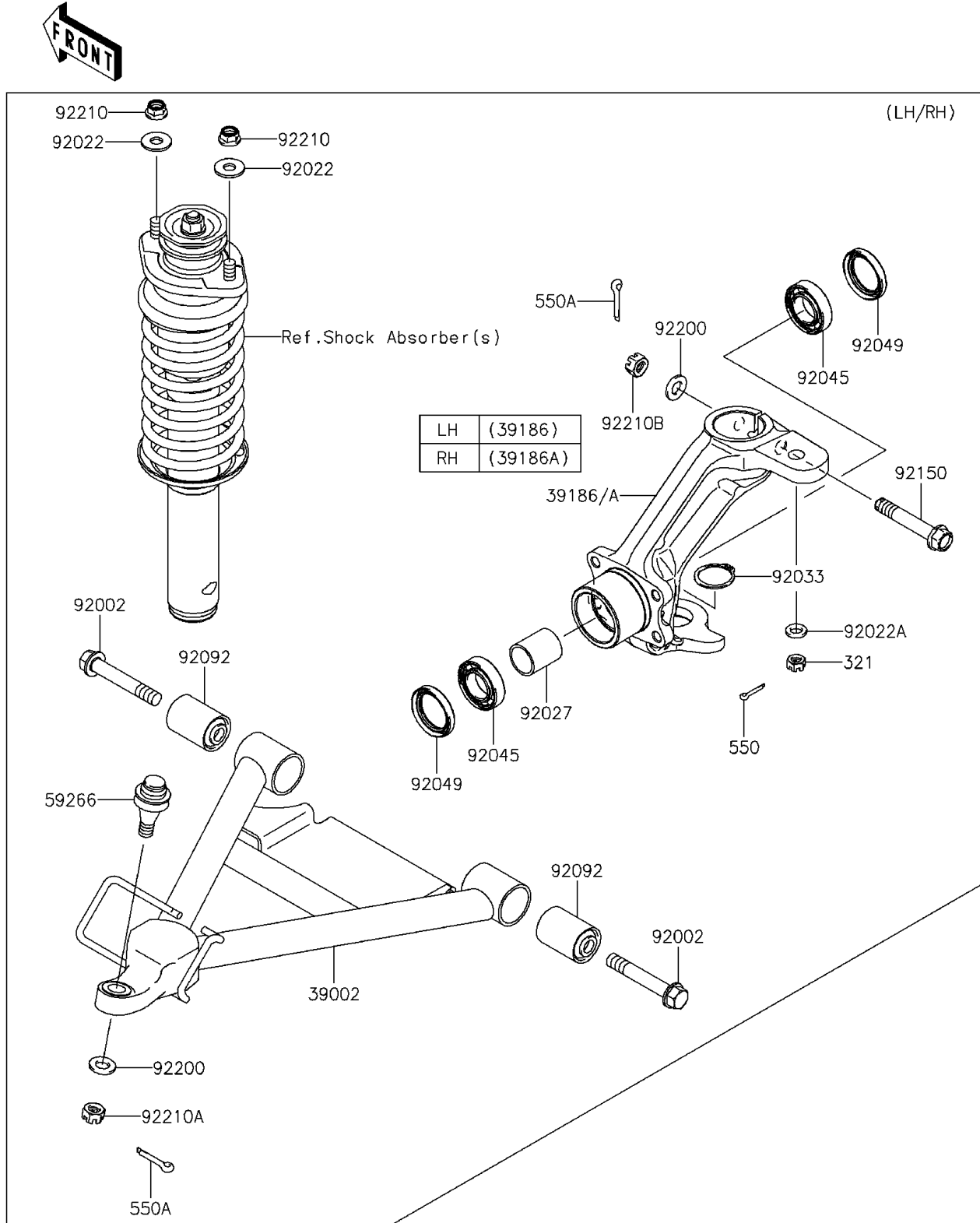

## 2014 MULE™ 4010 TRANS4x4® PARTS LIST

### Front Suspension

ITEM NAME	PART NUMBER	QUANTITY
ARM-COMP-SUSP (Ref # 39002)	39002-0001	2
KNUCKLE,FR,LH (Ref # 39186)	39186-0074	1
KNUCKLE,FR,RH (Ref # 39186A)	39186-0075	1
JOINT-BALL (Ref # 59266)	59266-1080	2
BOLT,FLANGED,12X75 (Ref # 92002)	92002-1661	4
WASHER,10.5X26X2.3 (Ref # 92022)	92022-044	4
WASHER,10.5X18X2.5 (Ref # 92022A)	92022-1876	2
COLLAR,L=34.5 (Ref # 92027)	92027-1538	2
RING-SNAP,C-TYPE,32MM (Ref # 92033)	92033-1262	2
BEARING-BALL,60052RD (Ref # 92045)	92045-0105	4
SEAL-OIL,SD35X47X7HS (Ref # 92049)	92049-1513	4
BUSHING-RUBBER (Ref # 92092)	92092-1065	4
BOLT,FLANGED,12X72 (Ref # 92150)	92150-1356	2
WASHER,12.3X23X2.3 (Ref # 92200)	92200-1004	4
NUT,LOCK,FLANGED,10MM (Ref # 92210)	92210-0276	4
NUT,CASTLE,12MM (Ref # 92210A)	92210-0395	2
NUT,12MM (Ref # 92210B)	92210-7501	2
NUT-CASTLE (Ref # 321)	321BA1000	2
PIN-COTTER,2.0X22 (Ref # 550)	550AA2022	2
PIN-COTTER,3.0X25 (Ref # 550A)	550AA3025	4