

2023 NINJA H2®R PARTS DIAGRAM

Fuel Injection

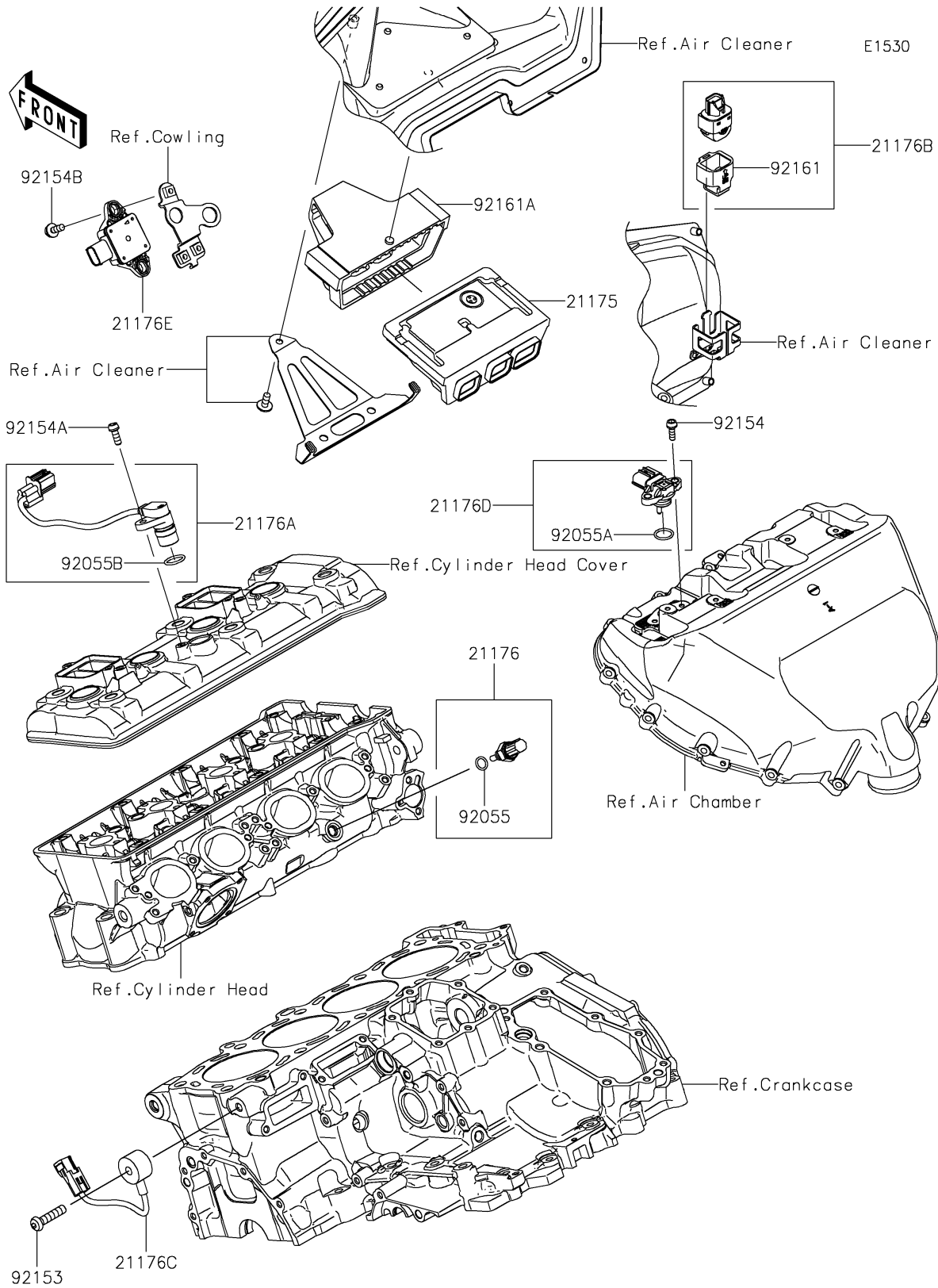

2023 NINJA H2® R PARTS LIST

Fuel Injection

ITEM NAME	PART NUMBER	QUANTITY
CONTROL UNIT-ELECTRONIC (Ref # 21175)	21175-1237	1
SENSOR,WATER TEMP (Ref # 21176)	21176-0009	1
SENSOR,CAM (Ref # 21176A)	21176-0101	1
SENSOR,VEHICLE-DOWN (Ref # 21176B)	21176-0704	1
SENSOR,KNOCK (Ref # 21176C)	21176-0788	1
SENSOR,INTAKE TEMP&PRESSURE (Ref # 21176D)	21176-0791	1
SENSOR,GYRO (Ref # 21176E)	21176-0819	1
RING-O,9.5X1.9 (Ref # 92055)	92055-0016	1
RING-O (Ref # 92055A)	92055-0842	1
RING-O (Ref # 92055B)	92055-1639	1
BOLT,SOCKET,8X35 (Ref # 92153)	92153-0419	1
BOLT,SOCKET,5X16 (Ref # 92154)	92154-1449	2
BOLT,SOCKET,6X16 (Ref # 92154A)	92154-1454	1
BOLT,FLANGED,6X16 (Ref # 92154B)	92154-1851	2
DAMPER (Ref # 92161)	92161-0951	1
DAMPER,ECU (Ref # 92161A)	92161-1719	1