

2008 KX™ 65 PARTS DIAGRAM

Footrests

F2160

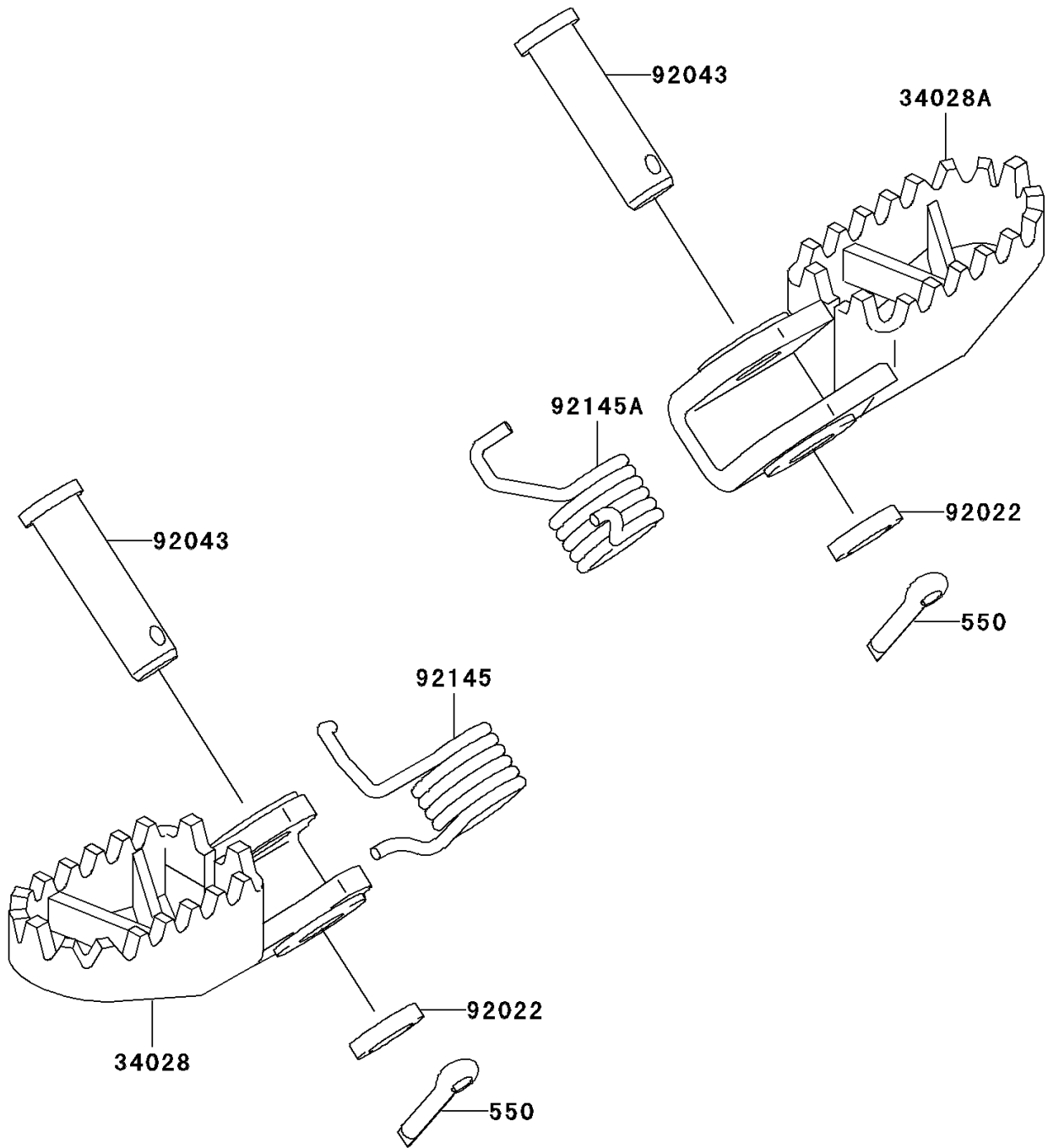

2008 KX™ 65 PARTS LIST

Footrests

ITEM NAME	PART NUMBER	QUANTITY
PIN-COTTER,3.0X20 (Ref # 550)	550S3020	2
STEP,LH,SILVER (Ref # 34028)	34028-1529-CE	1
STEP,RH,SILVER (Ref # 34028A)	34028-1530-CE	1
WASHER,10.2X16X1 (Ref # 92022)	92022-1829	2
PIN,10X37.5 (Ref # 92043)	92043-1643	2
SPRING,STEP,LH (Ref # 92145)	92145-1106	1
SPRING,STEP,RH (Ref # 92145A)	92145-1107	1