

2010 Z750 (European) PARTS DIAGRAM

Oil Pan

E1434

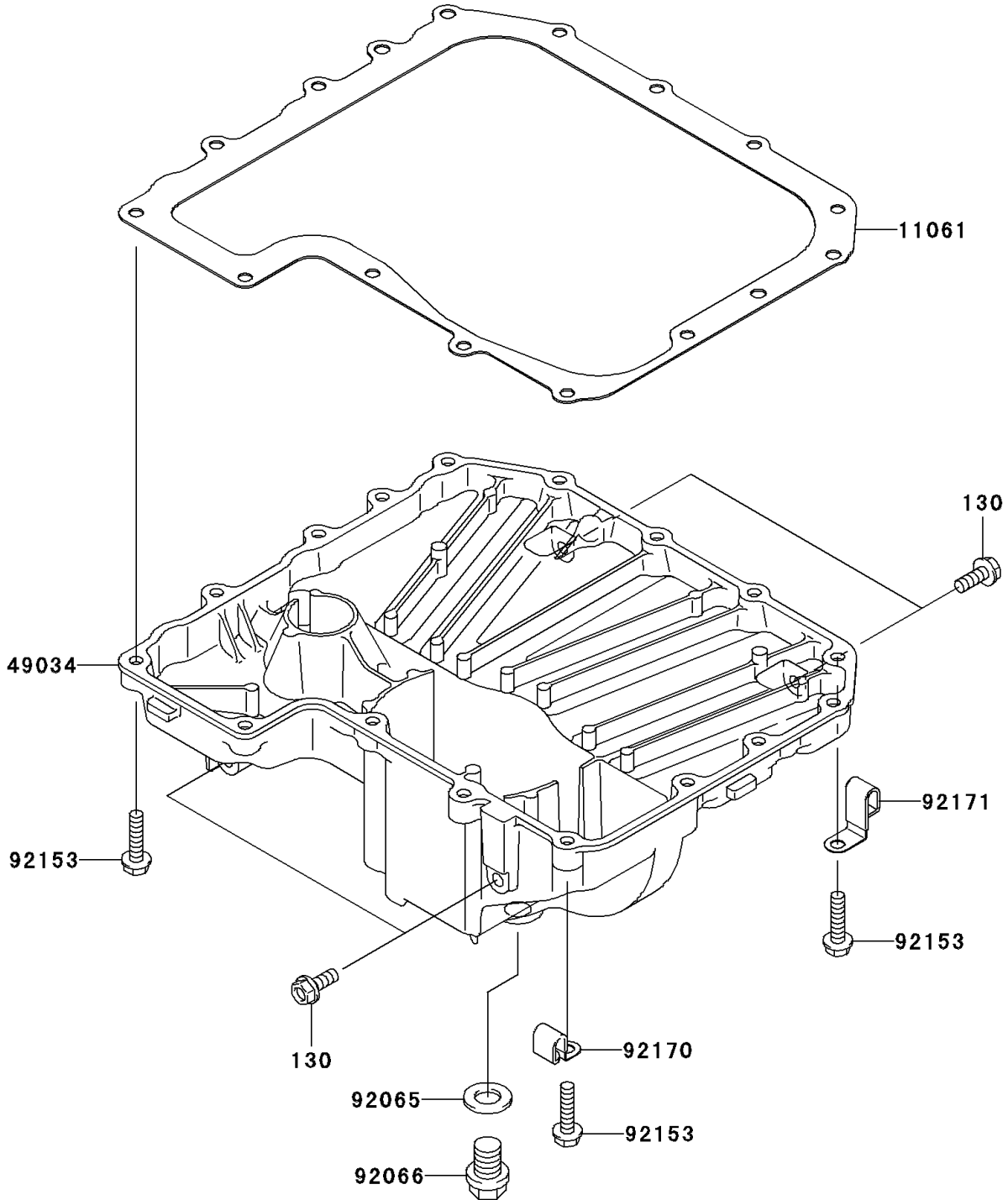

2010 Z750 (European) PARTS LIST

Oil Pan

ITEM NAME	PART NUMBER	QUANTITY
BOLT-FLANGED,6X16 (Ref # 130)	130BB0616	4
GASKET,OIL PAN (Ref # 11061)	11061-1167	1
PAN-OIL (Ref # 49034)	49034-0029	1
GASKET,12X22X2 (Ref # 92065)	92065-097	1
PLUG,OIL DRAIN,12X15 (Ref # 92066)	92066-1174	1
BOLT-FLANGED,6X25 (Ref # 92153)	92153-1569	16
CLAMP (Ref # 92170)	92170-1577	1
CLAMP (Ref # 92171)	92171-0926	1