

2021 MULE SX™ 4x4 XC FI PARTS DIAGRAM

Optional Parts(Engine)

F2890



(Ref. Drive Converter)

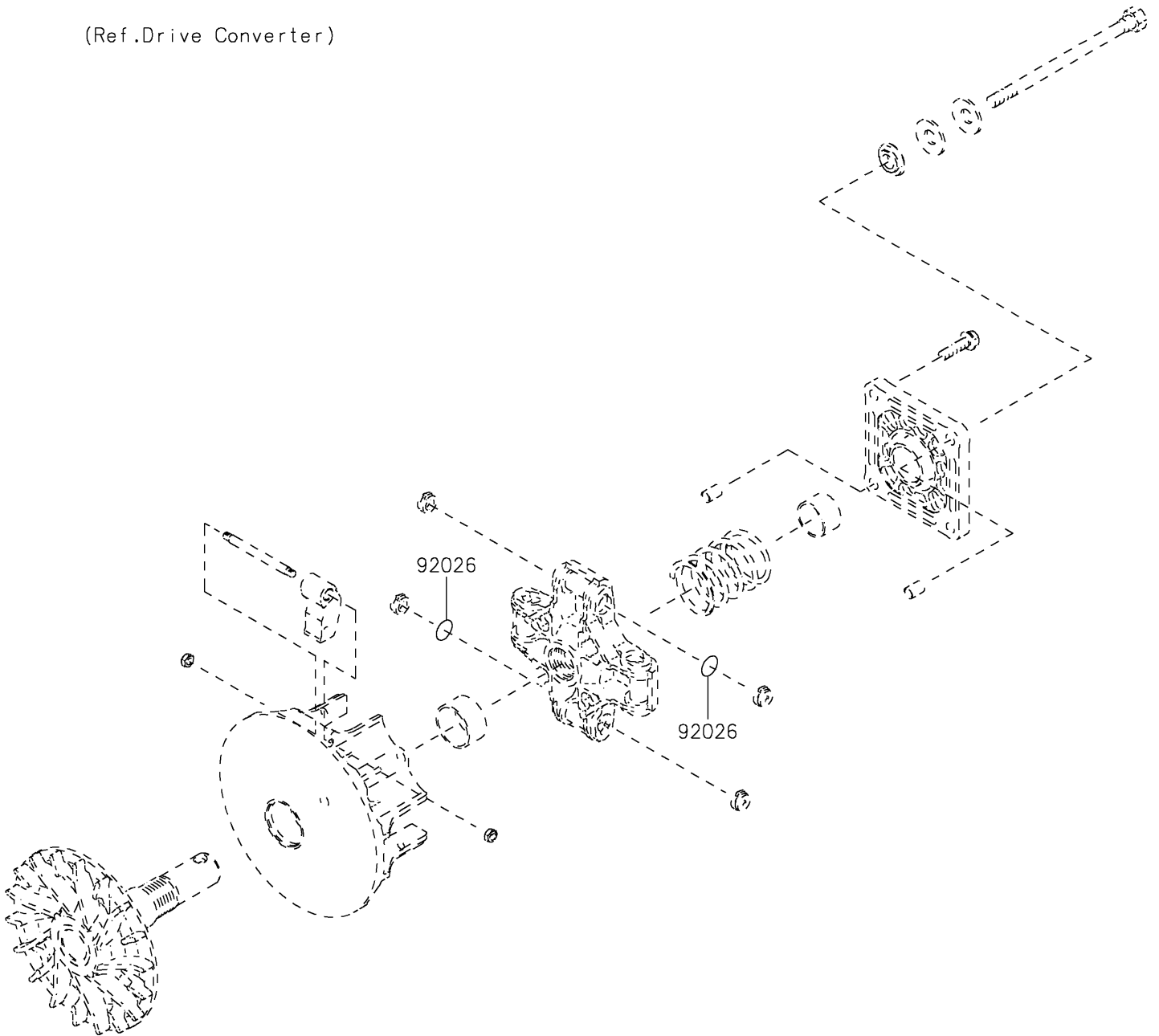

2021 MULE SX™ 4x4 XC FI PARTS LIST

Optional Parts(Engine)

ITEM NAME	PART NUMBER	QUANTITY
SPACER,T=0.1 (Ref # 92026)	92026-0038	2