

# 2021 MULE™ 4010 4x4 PARTS DIAGRAM

## Front Fender(s)

F2171

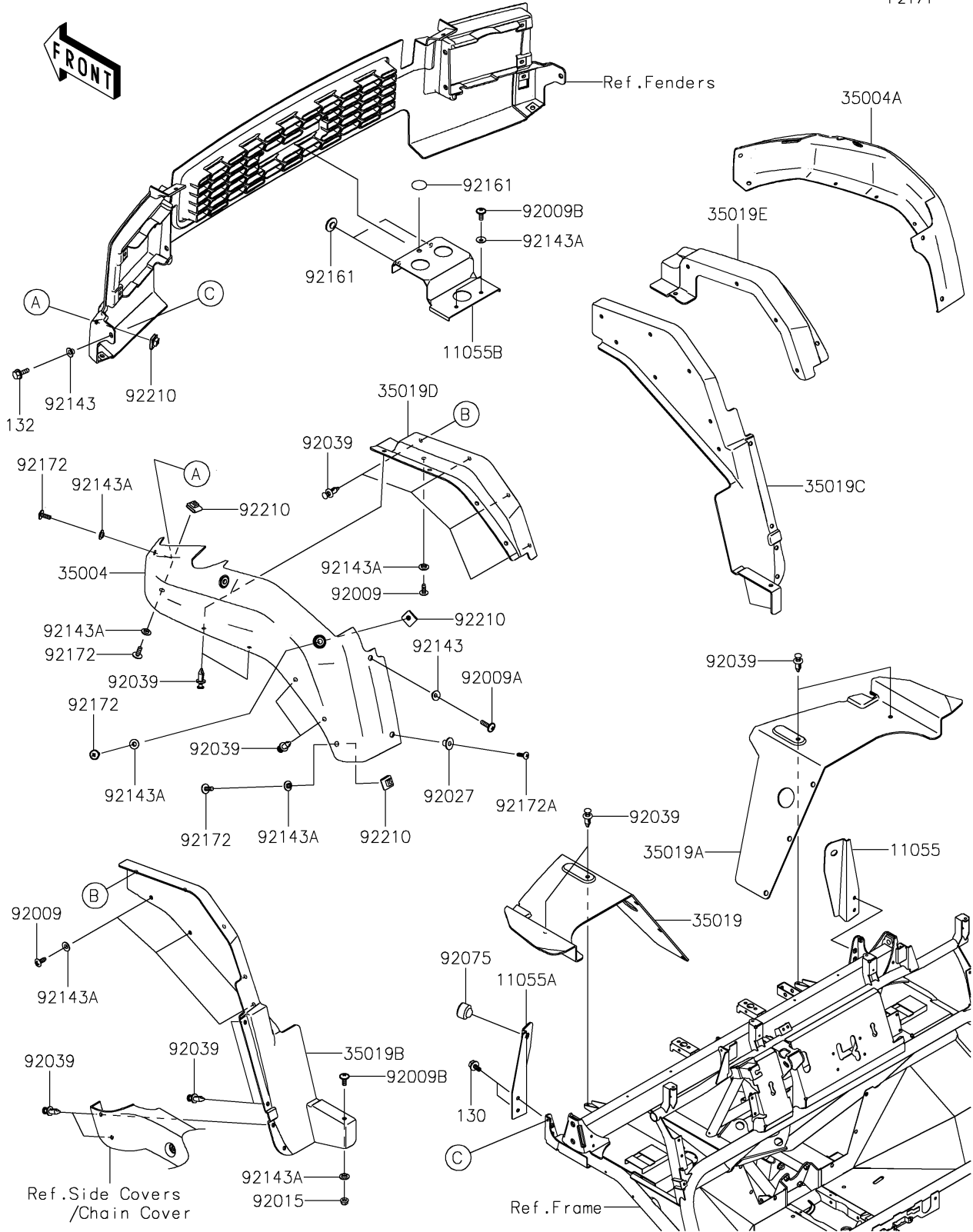

## 2021 MULE™ 4010 4x4 PARTS LIST

### Front Fender(s)

ITEM NAME	PART NUMBER	QUANTITY
BRACKET (Ref # 11055)	11055-0917	1
BRACKET (Ref # 11055A)	11055-0918	1
BRACKET (Ref # 11055B)	11055-0954	1
FENDER-FRONT,SIDE,LH,F.BLACK (Ref # 35004)	35004-0123-6Z	1
FENDER-FRONT,SIDE,RH,F.BLACK (Ref # 35004A)	35004-0124-6Z	1
FLAP,FR,LH (Ref # 35019)	35019-0062	1
FLAP,FR,RH (Ref # 35019A)	35019-0063	1
FLAP,SIDE,RR,LH (Ref # 35019B)	35019-0064	1
FLAP,SIDE,RR,RH (Ref # 35019C)	35019-0065	1
FLAP,SIDE,MIDDLE,LH (Ref # 35019D)	35019-0068	1
FLAP,SIDE,MIDDLE,RH (Ref # 35019E)	35019-0069	1
SCREW,TAPPING,6X16 (Ref # 92009)	92009-1166	8
SCREW,6X22,BLACK (Ref # 92009A)	92009-1256	2
SCREW,6X16 (Ref # 92009B)	92009-1621	4
NUT,LOCK,FLANGED,6MM (Ref # 92015)	92015-1675	2
COLLAR (Ref # 92027)	92027-1767	2
RIVET (Ref # 92039)	92039-0776	28
DAMPER (Ref # 92075)	92075-015	2
COLLAR (Ref # 92143)	92143-1057	4
COLLAR (Ref # 92143A)	92143-1087	22
DAMPER,RUBBER (Ref # 92161)	92161-1200	3
SCREW,TAPPING,6X20 (Ref # 92172)	92172-0488	10
SCREW (Ref # 92172A)	92172-1072	2
NUT,LEAF SPRING,6MM (Ref # 92210)	92210-0624	10
BOLT-FLANGED,6X14 (Ref # 130)	130BA0614	4
BOLT-FLANGED-SMALL,6X20 (Ref # 132)	132BA0620	2