

2022 MULE™ 4010 TRANS4x4® PARTS DIAGRAM

Gear Change Mechanism

E1370

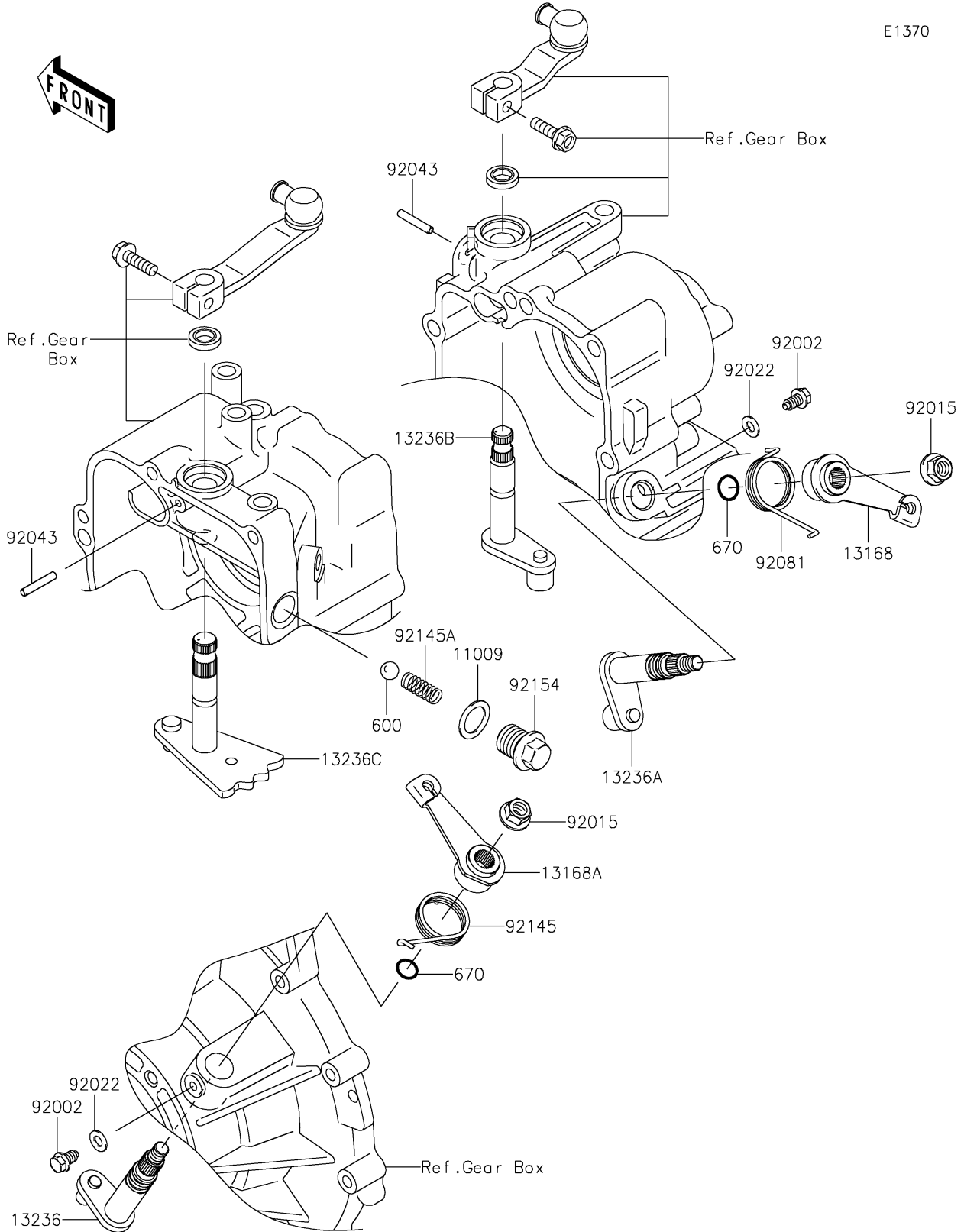

2022 MULE™ 4010 TRANS4x4® PARTS LIST

Gear Change Mechanism

ITEM NAME	PART NUMBER	QUANTITY
GASKET,15.5X22X1 (Ref # 11009)	11009-1008	1
LEVER (Ref # 13168)	13168-1268	1
LEVER,DIFF LOCK (Ref # 13168A)	13168-1523	1
LEVER-COMP,DIFF LOCK (Ref # 13236)	13236-1219	1
LEVER-COMP,CHANGE,2WD/4WD (Ref # 13236A)	13236-1247	1
LEVER-COMP,HI/LOW (Ref # 13236B)	13236-1360	1
LEVER-COMP,FR/RR (Ref # 13236C)	13236-1366	1
BOLT,FLANGED-SMALL,6X8.1X2.5 (Ref # 92002)	92002-1962	2
NUT,FLANGED,8MM (Ref # 92015)	92015-1406	2
WASHER,6.1X12X1 (Ref # 92022)	92022-077	2
PIN (Ref # 92043)	92043-1415	2
SPRING (Ref # 92081)	92081-1853	1
SPRING (Ref # 92145)	92145-0253	1
SPRING (Ref # 92145A)	92145-0949	1
BOLT,NEUTRAL POSITION (Ref # 92154)	92154-1139	1
BALL-STEEL,13/32 (Ref # 600)	600A1300	1
O RING,10MM (Ref # 670)	670B2010	2