

2005 Ninja® ZX™-10R PARTS DIAGRAM

Swingarm

F2141

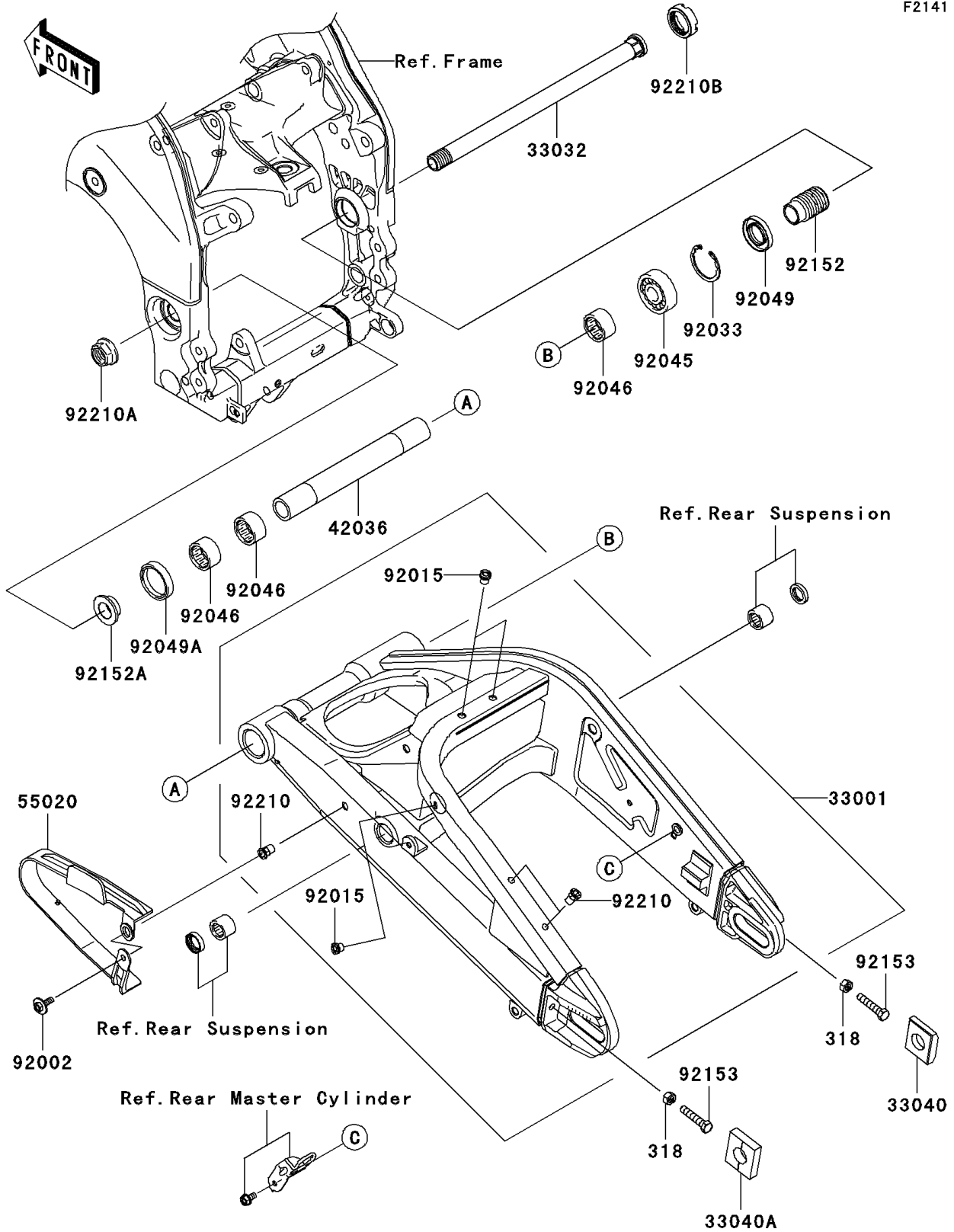

2005 Ninja® ZX™-10R PARTS LIST

Swingarm

ITEM NAME	PART NUMBER	QUANTITY
NUT-HEX-SMALL (Ref # 318)	318L0800	2
ARM-COMP-SWING,F.S.BLACK (Ref # 33001)	33001-0039-8F	1
SHAFT-SWING ARM (Ref # 33032)	33032-0009	1
ADJUSTER-CHAIN,RH (Ref # 33040)	33040-0008	1
ADJUSTER-CHAIN (Ref # 33040A)	33040-1109	1
SLEEVE,SWING ARM PIVOT,L=226 (Ref # 42036)	42036-1341	1
GUARD,CHAIN (Ref # 55020)	55020-0101	1
BOLT,6X16 (Ref # 92002)	92002-1187	1
NUT,POP,6MM,L=15 (Ref # 92015)	92015-1791	3
RING-SNAP,42MM (Ref # 92033)	92033-1041	1
BEARING-BALL,6004UL11 (Ref # 92045)	92045-0017	1
BEARING-NEEDLE,7E-HVS 28X34X17 (Ref # 92046)	92046-0008	3
SEAL-OIL,MHSA25 42 6 (Ref # 92049)	92049-1314	1
SEAL-OIL,MHSA25X34X7 (Ref # 92049A)	92049-1352	1
COLLAR,SWING ARM,L=47 (Ref # 92152)	92152-0154	1
COLLAR,SWING ARM,L=12.5 (Ref # 92152A)	92152-1234	1
BOLT,8X40 (Ref # 92153)	92153-0736	2
NUT,6MM (Ref # 92210)	92210-0099	3
NUT,FLANGED,20MM (Ref # 92210A)	92210-0106	1
NUT,30MM (Ref # 92210B)	92210-0134	1