

2006 Ninja® ZX™-10R PARTS DIAGRAM

Oil Pump/Oil Filter

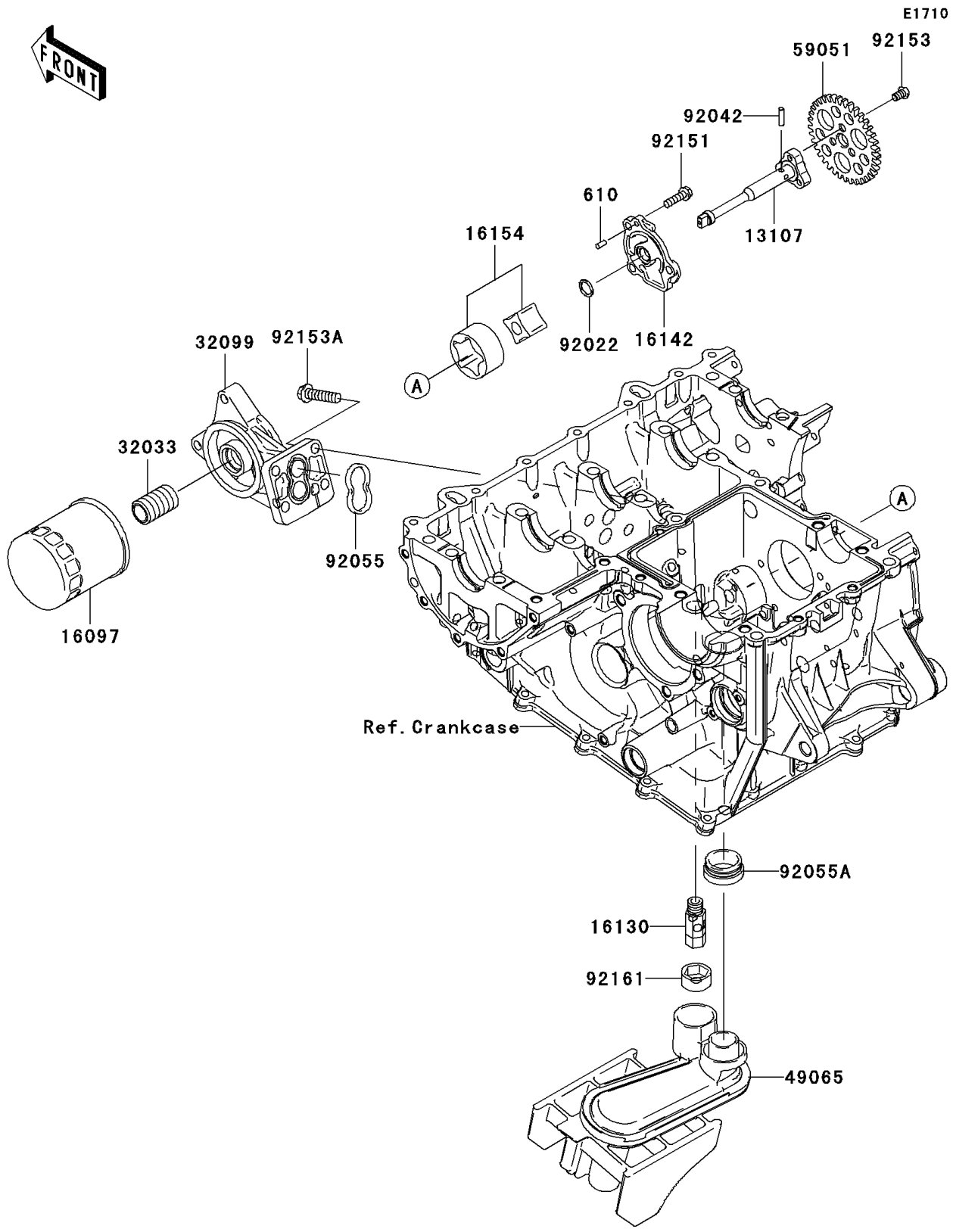

2006 Ninja® ZX™-10R PARTS LIST

Oil Pump/Oil Filter

ITEM NAME	PART NUMBER	QUANTITY
ROLLER,4X8 (Ref # 610)	610A0408	1
SHAFT (Ref # 13107)	13107-0060	1
FILTER-ASSY-OIL (Ref # 16097)	16097-0004	1
VALVE-ASSY-RELIEF (Ref # 16130)	16130-1059	1
COVER-PUMP (Ref # 16142)	16142-0005	1
ROTOR-PUMP (Ref # 16154)	16154-1124	1
PIPE,OIL FILTER (Ref # 32033)	32033-1535	1
CASE,OIL FILTER (Ref # 32099)	32099-0023	1
FILTER-OIL (Ref # 49065)	49065-0013	1
GEAR-SPUR,37T (Ref # 59051)	59051-0038	1
WASHER,11.2X15X1 (Ref # 92022)	92022-311	1
PIN,DOWEL,4X15.8 (Ref # 92042)	92042-014	1
RING-O,OIL LINE (Ref # 92055)	92055-0018	1
RING-O,OIL FILTER (Ref # 92055A)	92055-1503	1
BOLT,FLANGED-SMALL,6X20 (Ref # 92151)	92151-1252	3
BOLT,TORX,M6X10 (Ref # 92153)	92153-0661	3
BOLT,FLANGED,8X30 (Ref # 92153A)	92153-1086	4
DAMPER (Ref # 92161)	92161-0070	1