

2021 KX™ 65 PARTS DIAGRAM

Crankcase

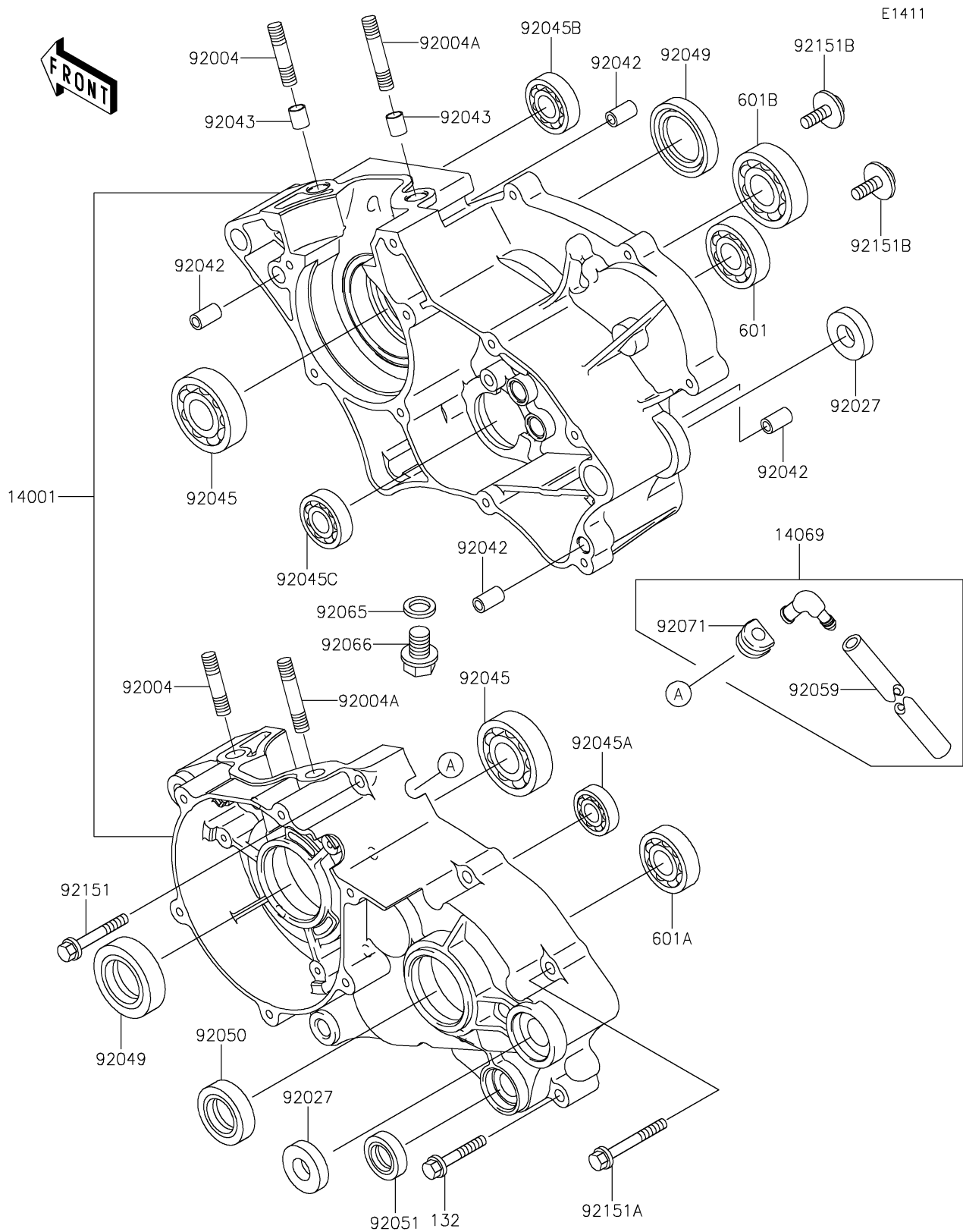

2021 KX™ 65 PARTS LIST

Crankcase

ITEM NAME	PART NUMBER	QUANTITY
SET-CRANKCASE (Ref # 14001)	14001-0119	1
BREATHER (Ref # 14069)	14069-1003	1
STUD,8X30 (Ref # 92004)	92004-0019	2
STUD,8X38 (Ref # 92004A)	92004-0020	2
COLLAR,12.1X26X6 (Ref # 92027)	92027-1744	2
PIN,DOWEL,6.3X8X14 (Ref # 92042)	92042-007	4
PIN,8.2X10X14 (Ref # 92043)	92043-1264	2
BEARING-BALL,R-6304C3 (Ref # 92045)	92045-1059	2
BEARING-BALL,6001C3ML01 (Ref # 92045A)	92045-1235	1
BEARING-BALL,626MC3 (Ref # 92045B)	92045-1304	1
BEARING-BALL,6805JRZ (Ref # 92045C)	92045-1432	1
SEAL-OIL,SD20407GS (Ref # 92049)	92049-1188	2
SEAL-OIL,SC25376 (Ref # 92050)	92050-013	1
SEAL-OIL,TB13225.5 (Ref # 92051)	92051-005	1
TUBE,6X9X280 (Ref # 92059)	92059-1074	1
GASKET,10.5X16X1 (Ref # 92065)	92065-058	1
PLUG,DRAIN (Ref # 92066)	92066-1437	1
GROMMET,BREATHER (Ref # 92071)	92071-042	1
BOLT,6X40 (Ref # 92151)	92151-1131	5
BOLT,6X55 (Ref # 92151A)	92151-1132	1
BOLT,6X16 (Ref # 92151B)	92151-1762	2
BOLT-FLANGED-SMALL,6X35 (Ref # 132)	132BA0635	3
BEARING-BALL,#6002 (Ref # 601)	601A6002	1
BEARING-BALL,#6004 (Ref # 601A)	601A6004	1
BEARING-BALL,#6203 (Ref # 601B)	601A6203	1