

2025 KX™ 65 PARTS DIAGRAM

Engine Cover(s)

E1431

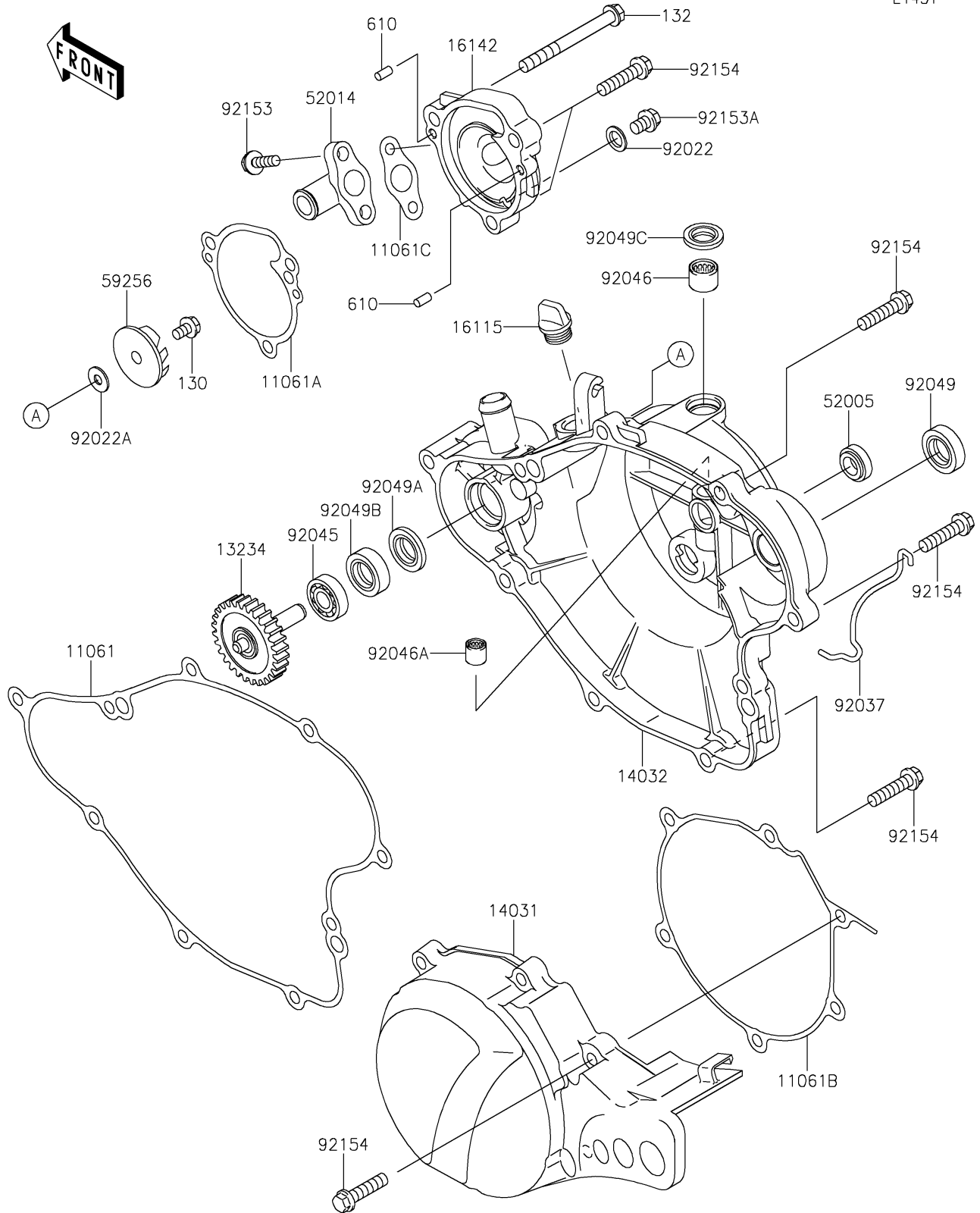

2025 KX™65 PARTS LIST

Engine Cover(s)

ITEM NAME	PART NUMBER	QUANTITY
GASKET,CLUTCH COVER (Ref # 11061)	11061-0121	1
GASKET,WATER PUMP COVER (Ref # 11061A)	11061-0159	1
GASKET,GENERATOR COVER (Ref # 11061B)	11061-0193	1
GASKET,ELBOW (Ref # 11061C)	11061-0202	1
SHAFT-COMP,PUMP (Ref # 13234)	13234-1110	1
COVER-GENERATOR (Ref # 14031)	14031-0579	1
COVER-CLUTCH (Ref # 14032)	14032-0623	1
CAP-OIL FILLER (Ref # 16115)	16115-018	1
COVER-PUMP (Ref # 16142)	16142-0023	1
GAUGE,OIL LEVEL (Ref # 52005)	52005-0019	1
ELBOW (Ref # 52014)	52014-1094	1
IMPELLER (Ref # 59256)	59256-1064	1
WASHER,6.1X12X1 (Ref # 92022)	92022-077	1
WASHER,5.2X13X1 (Ref # 92022A)	92022-1380	1
CLAMP,TUBE (Ref # 92037)	92037-1236	1
BEARING-BALL,608MC3 (Ref # 92045)	92045-1305	1
BEARING-NEEDLE,HK1010FM (Ref # 92046)	92046-0046	1
BEARING-NEEDLE,6BTM109 (Ref # 92046A)	92046-1217	1
SEAL-OIL,SB16244 (Ref # 92049)	92049-002	1
SEAL-OIL,MH8X18X3.5-A (Ref # 92049A)	92049-1359	1
SEAL-OIL,MHSD8X18X10J-1 (Ref # 92049B)	92049-1366	1
SEAL-OIL,BG1408F0 (Ref # 92049C)	92049-1414	1
BOLT,5X16 (Ref # 92153)	92153-0859	2
BOLT,6X8 (Ref # 92153A)	92153-0860	1
BOLT,FLANGED,6X25 (Ref # 92154)	92154-0520	16
BOLT-FLANGED,5X10 (Ref # 130)	130CA0510	1
BOLT-FLANGED-SMALL,6X60 (Ref # 132)	132BC0660	1
ROLLER,4X8 (Ref # 610)	610A0408	2