

2024 KX™65 PARTS DIAGRAM

Shock Absorber(s)

F2280

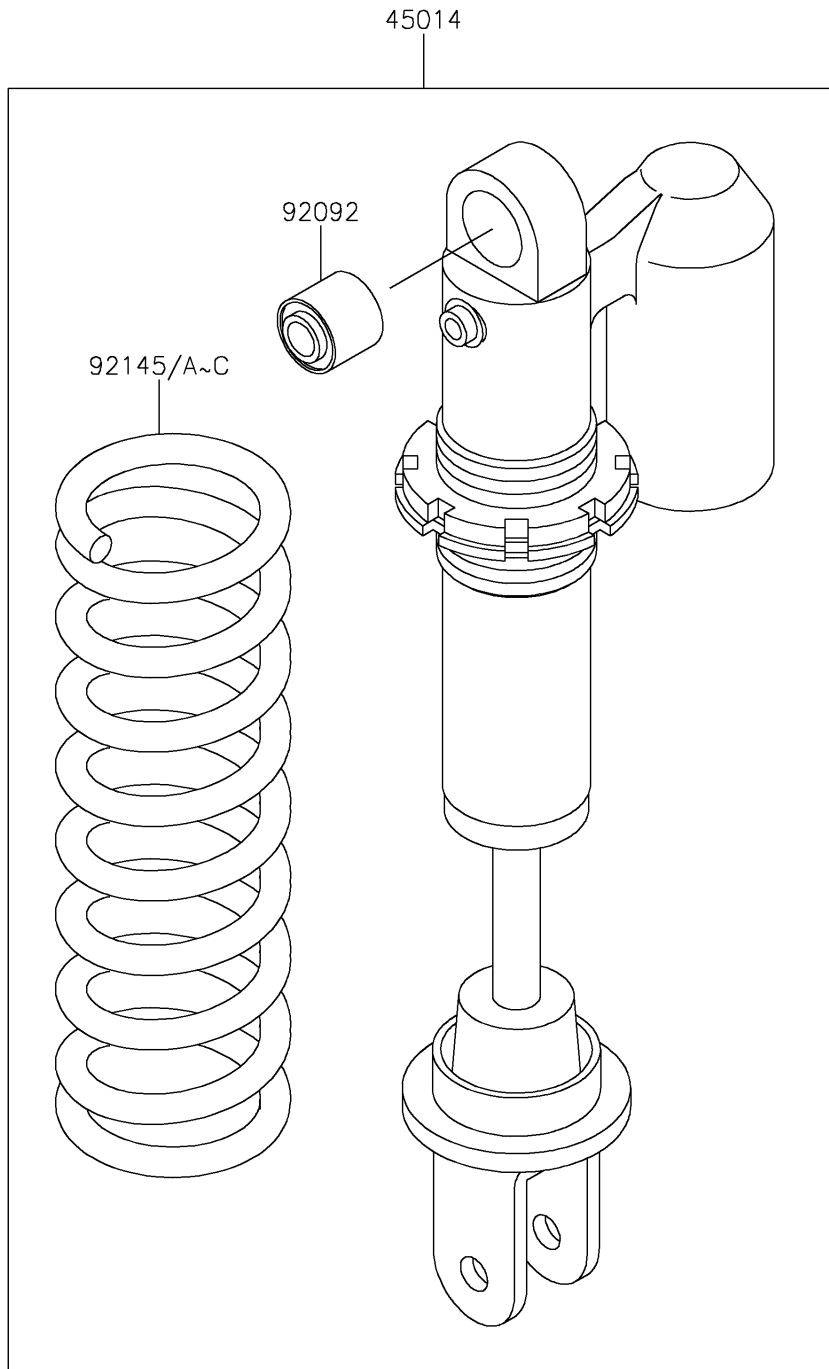

2024 KX™65 PARTS LIST

Shock Absorber(s)

ITEM NAME	PART NUMBER	QUANTITY
SHOCKABSORBER,BLACK (Ref # 45014)	45014-0120-10	1
BUSHING-RUBBER (Ref # 92092)	92092-1078	1
SPRING,SHOCK,K=44.1N/MM,BLK (Ref # 92145)	92145-1474-10	1
SPRING,SHOCK,K=46.1N/MM,BLK (Ref # 92145A)	92145-1475-10	1
SPRING,SHOCK,K=48.1N/MM,BLK (Ref # 92145B)	92145-1476-10	1
SPRING,SHOCK,K=50.0N/MM,BLK (Ref # 92145C)	92145-1477-10	1