

2023 KX™112 PARTS DIAGRAM

Crankshaft/Piston(s)

E1320

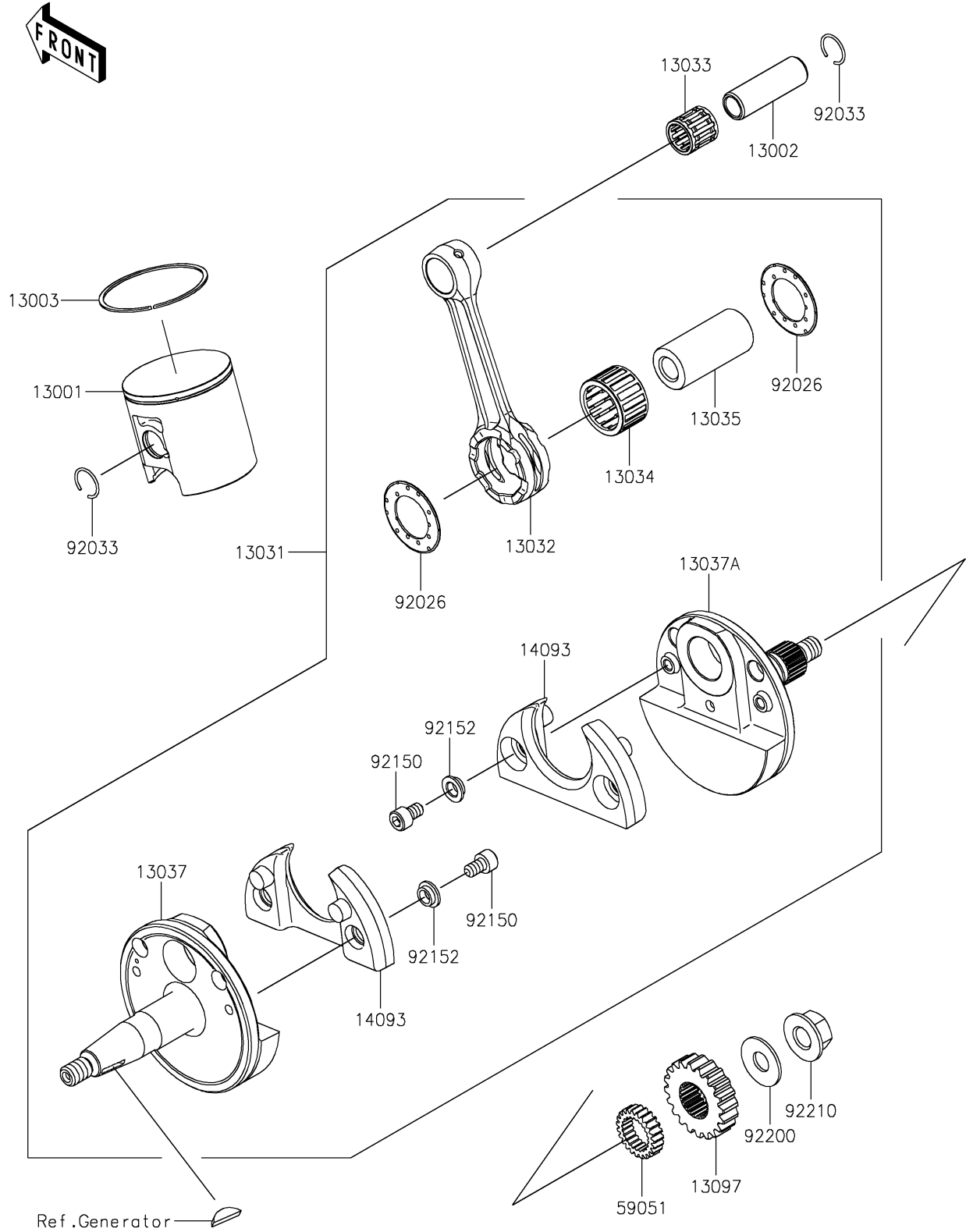

2023 KX™112 PARTS LIST

Crankshaft/Piston(s)

ITEM NAME	PART NUMBER	QUANTITY
PISTON-ENGINE (Ref # 13001)	13001-0833	1
PIN-PISTON (Ref # 13002)	13002-0730	1
RING-PISTON TOP (Ref # 13003)	13003-0762	1
CRANKSHAFT-COMP (Ref # 13031)	13031-0998	1
ROD-CONNECTING (Ref # 13032)	13032-0811	1
BEARING-SMALL END (Ref # 13033)	13033-0003	1
BEARING-BIG END,B4 (Ref # 13034)	13034-1099	1
PIN-CRANK (Ref # 13035)	13035-1054	1
CRANKSHAFT,LH (Ref # 13037)	13037-1723	1
CRANKSHAFT,RH (Ref # 13037A)	13037-1725	1
GEAR-PRIMARY SPUR,20T (Ref # 13097)	13097-1148	1
COVER (Ref # 14093)	14093-1160	2
GEAR-SPUR,PUMP,23T (Ref # 59051)	59051-0861	1
SPACER,22.2X37X1.0 (Ref # 92026)	92026-1136	2
RING-SNAP (Ref # 92033)	92033-0005	2
BOLT,SOCKET,6X10 (Ref # 92150)	92150-1650	4
COLLAR (Ref # 92152)	92152-2871	4
WASHER,10.2X25X1.5 (Ref # 92200)	92200-0213	1
NUT,FLANGED,10MM (Ref # 92210)	92210-1919	1