

2024 KLX110L PARTS DIAGRAM

Chassis Electrical Equipment

F2760

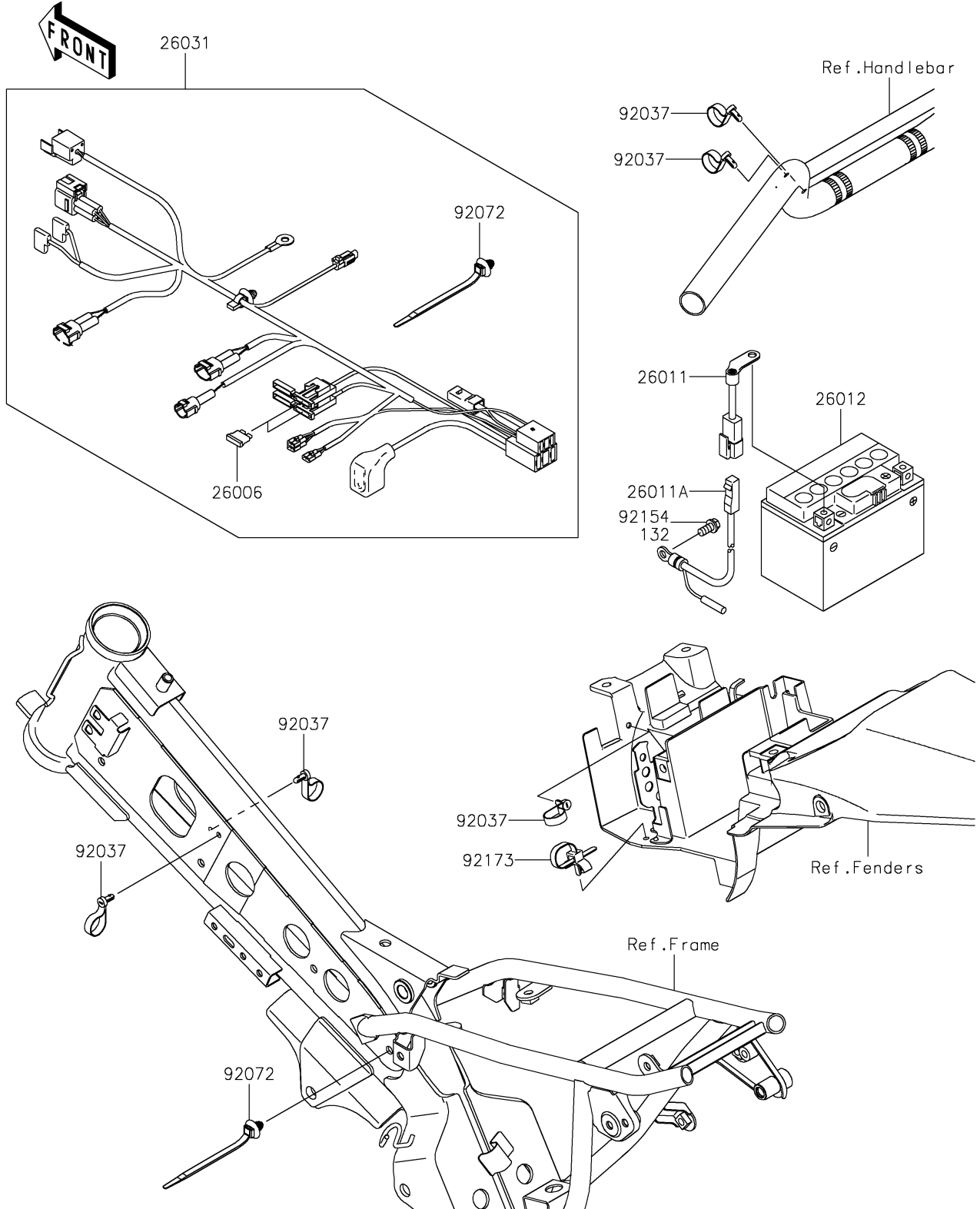

2024 KLX110L PARTS LIST

Chassis Electrical Equipment

ITEM NAME	PART NUMBER	QUANTITY
FUSE,MINI BLADE,10A,RED (Ref # 26006)	26006-0009	2
WIRE-LEAD (Ref # 26011)	26011-0245	1
WIRE-LEAD (Ref # 26011A)	26011-0289	1
BATTERY,FTH4L-BS,12V 3AH (Ref # 26012)	26012-0984	1
HARNESS,MAIN (Ref # 26031)	26031-1106	1
CLAMP,SPEED,L=58 (Ref # 92037)	92037-1163	5
BAND,OS170-FT7(BLACK) (Ref # 92072)	92072-1414	2
BOLT,FLANGED,6X12 (Ref # 92154)	92154-2753	1
CLAMP (Ref # 92173)	92173-1512	1
BOLT-FLANGED-SMALL,6X12 (Ref # 132)	132BA0612	1