

1993 Ninja® ZX™ -11 PARTS DIAGRAM

Seat

F2510

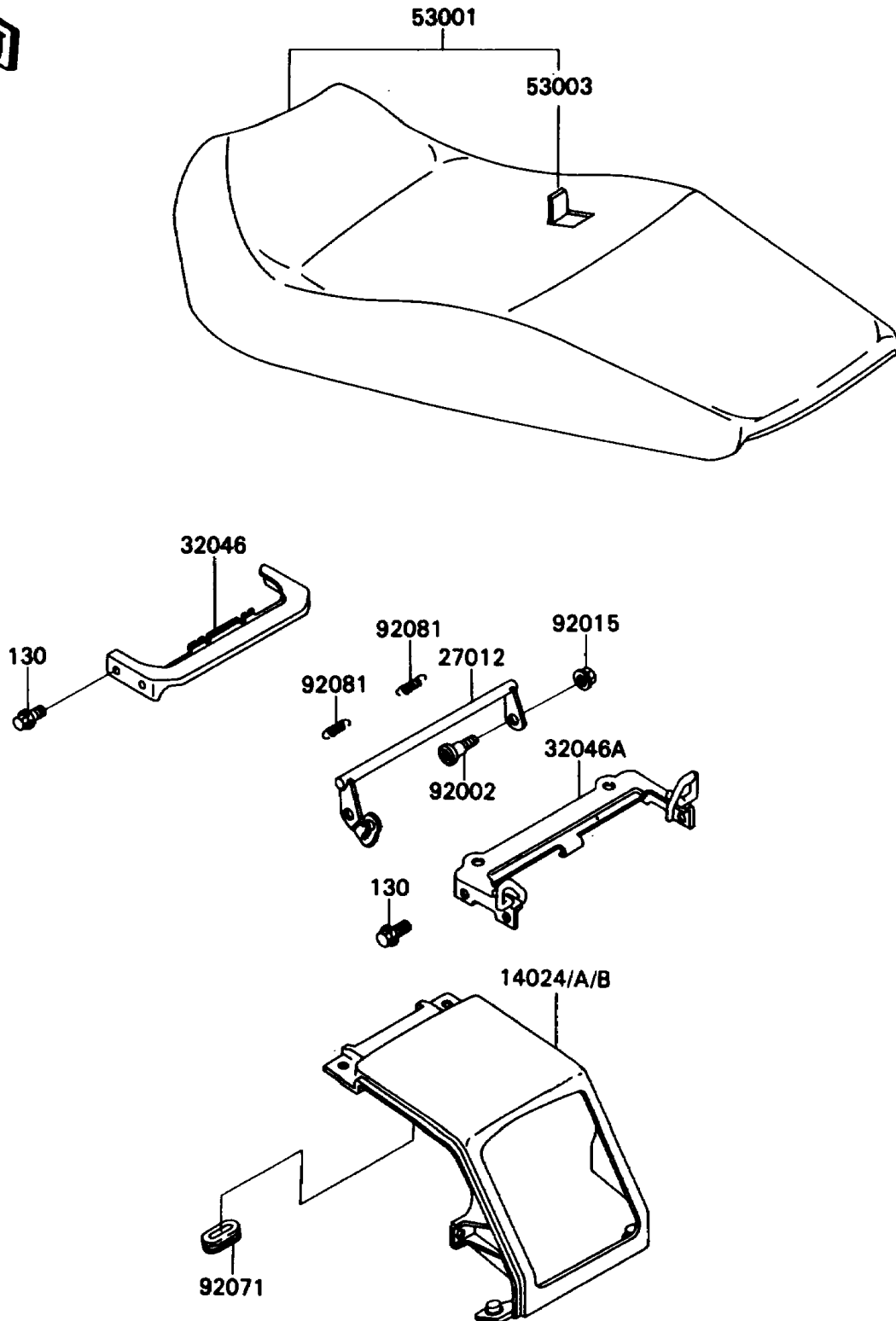

1993 Ninja® ZX™ -11 PARTS LIST

Seat

ITEM NAME	PART NUMBER	QUANTITY
-----------	-------------	----------