

1991 Ninja® ZX™-11 PARTS DIAGRAM

Electrical Equipment

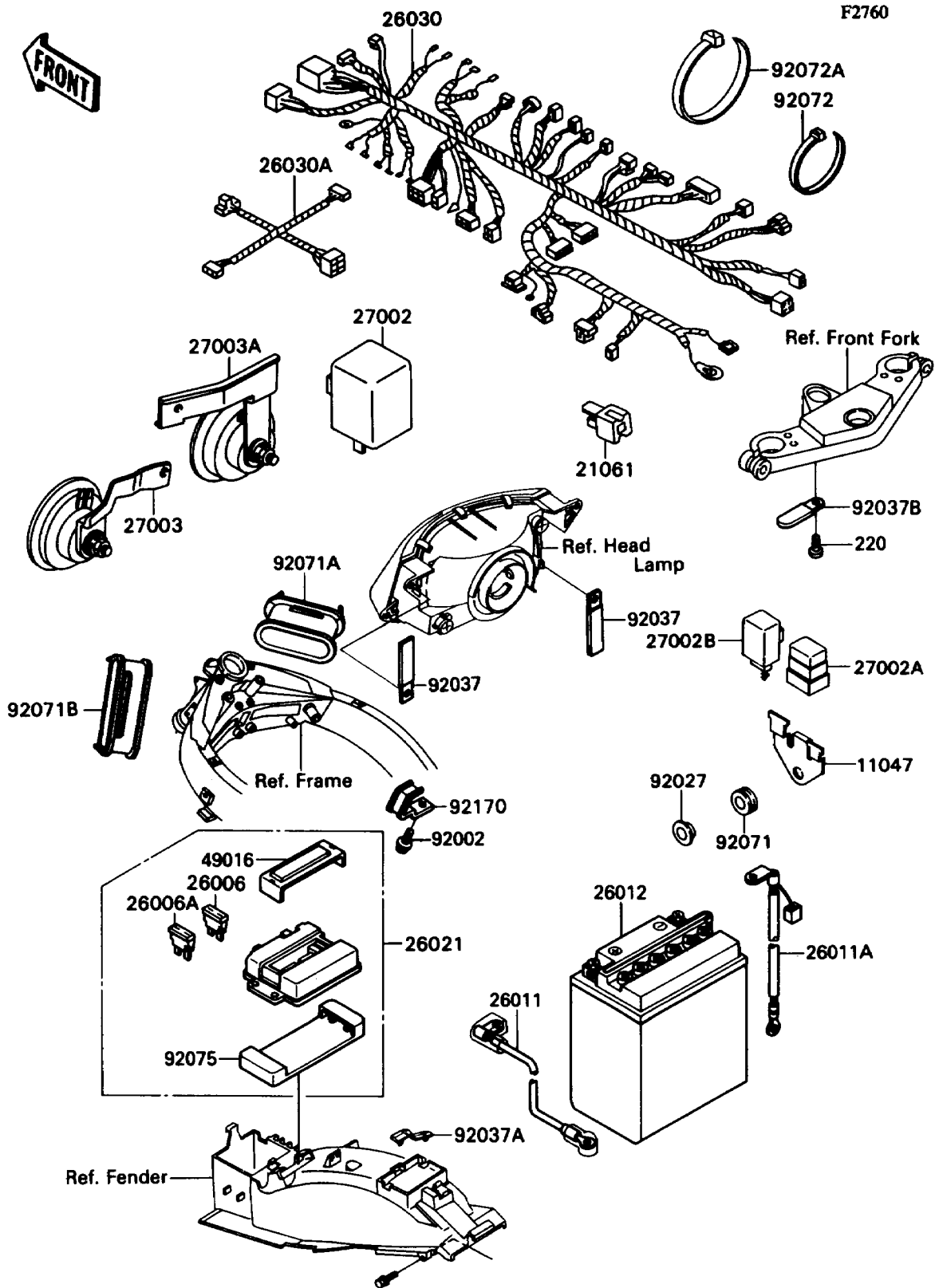

1991 Ninja® ZX™ -11 PARTS LIST

Electrical Equipment

ITEM NAME	PART NUMBER	QUANTITY
BRACKET,RELAY (Ref # 11047)	11047-1111	1
RECTIFIER (Ref # 21061)	21061-1003	2
FUSE,30A-G (Ref # 26006)	26006-1067	1
FUSE,10A-R (Ref # 26006A)	26006-1068	5
WIRE-LEAD,BATTERY(+) (Ref # 26011)	26011-1464	1
WIRE-LEAD,BATTERY(-) (Ref # 26011A)	26011-1477	1
BATTERY,12V 15AH,FB14L-A2(K) (Ref # 26012)	26012-1224	1
JUNCTION BOX (Ref # 26021)	26021-1077	1
HARNESS,MAIN (Ref # 26030)	26030-1005	1
HARNESS,FR (Ref # 26030A)	26030-1006	1
RELAY-ASSY,TURN SIGNAL (Ref # 27002)	27002-1060	1
RELAY-ASSY,FUEL SENSOR (Ref # 27002A)	27002-1072	1
RELAY-ASSY,FUEL LAMP (Ref # 27002B)	27002-1073	1
HORN,LH (Ref # 27003)	27003-1320	1
HORN,RH (Ref # 27003A)	27003-1332	1
COVER-SEAL,FUSE (Ref # 49016)	49016-1125	1
BOLT,6X10 (Ref # 92002)	92002-1628	1
BOLT,6X10 (Ref # 92002)	92002-1628	2
COLLAR,L=7 (Ref # 92027)	92027-153	1
CLAMP,WIRING HARNESS (Ref # 92037)	92037-1069	2
CLAMP,HOSE (Ref # 92037A)	92037-1163	2
CLAMP,WIRING HARNESS (Ref # 92037B)	92037-1539	1
GROMMET (Ref # 92071)	92071-1115	1
GROMMET,HARNESS,RH (Ref # 92071A)	92071-1170	1
GROMMET,HARNESS,LH (Ref # 92071B)	92071-1180	1
BAND,L=185 (Ref # 92072)	92072-1195	7
BAND,L=365 (Ref # 92072A)	92072-1197	1
DAMPER,JUNCTION BOX (Ref # 92075)	92075-1688	1
CLAMP,HARNESS (Ref # 92170)	92170-1024	1