

2022 KLX®300 PARTS DIAGRAM

Crankcase

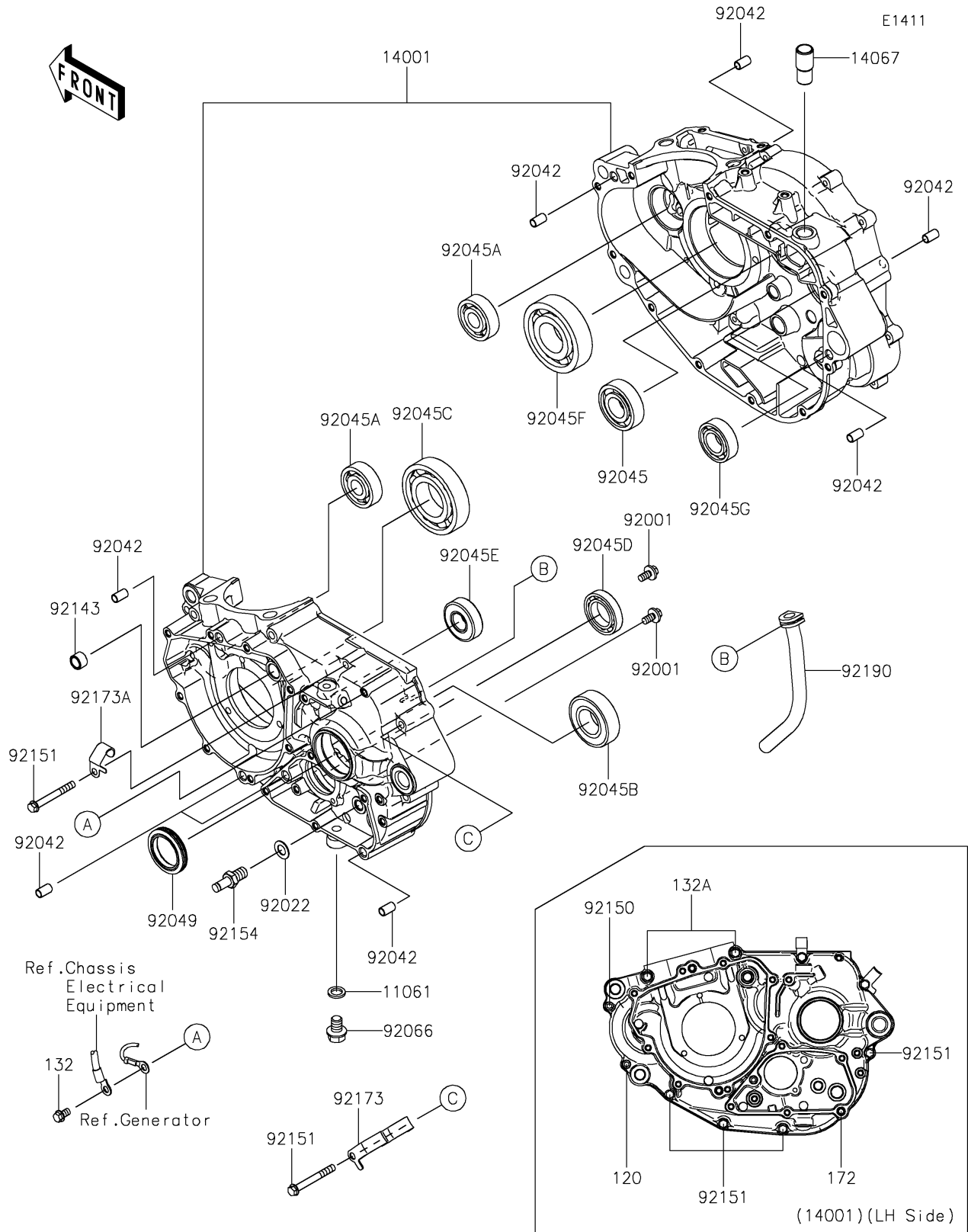

2022 KLX®300 PARTS LIST

Crankcase

ITEM NAME	PART NUMBER	QUANTITY
GASKET,10.5X16X2 (Ref # 11061)	11061-0222	1
SET-CRANKCASE (Ref # 14001)	14001-0728	1
FITTING,BREATHER (Ref # 14067)	14067-006	1
BOLT,W/WASHER,6X14 (Ref # 92001)	92001-1829	2
WASHER,10.2X18X1.0,SK5 (Ref # 92022)	92022-1415	1
PIN,DOWEL,6.3X8X14 (Ref # 92042)	92042-007	8
BEARING-BALL,20X47X14 (Ref # 92045)	92045-0752	1
BEARING-BALL,15X42X13 (Ref # 92045A)	92045-0753	2
BEARING-BALL,25X52X15 (Ref # 92045B)	92045-0756	1
BEARING-BALL,35X72X17 (Ref # 92045C)	92045-0757	1
BEARING-BALL,25X42X9 (Ref # 92045D)	92045-0761	1
BEARING-BALL,17X40X12 (Ref # 92045E)	92045-0938	1
BEARING-BALL,30X72X19 (Ref # 92045F)	92045-0941	1
BEARING-BALL,DG204012 (Ref # 92045G)	92045-1414	1
SEAL-OIL,32X45X7.5 (Ref # 92049)	92049-0825	1
PLUG,DRAIN (Ref # 92066)	92066-0143	1
COLLAR (Ref # 92143)	92143-1263	1
BOLT,SOCKET,6X35 (Ref # 92150)	92150-1875	1
BOLT,6X50 (Ref # 92151)	92151-1234	6
BOLT,RETURN SPRING (Ref # 92154)	92154-1306	1
CLAMP (Ref # 92173)	92173-1715	1
CLAMP (Ref # 92173A)	92173-2289	1
TUBE (Ref # 92190)	92190-1493	1
BOLT-SOCKET,6X50 (Ref # 120)	120CC0650	1
BOLT-FLANGED-SMALL (Ref # 132)	132BC0610	1
BOLT-FLANGED-SMALL,6X70 (Ref # 132A)	132BC0670	2
BOLT-STUD,6X80 (Ref # 172)	172BA0680	1