

1995 Ninja® ZX™ -11 PARTS DIAGRAM

Generator

E1810

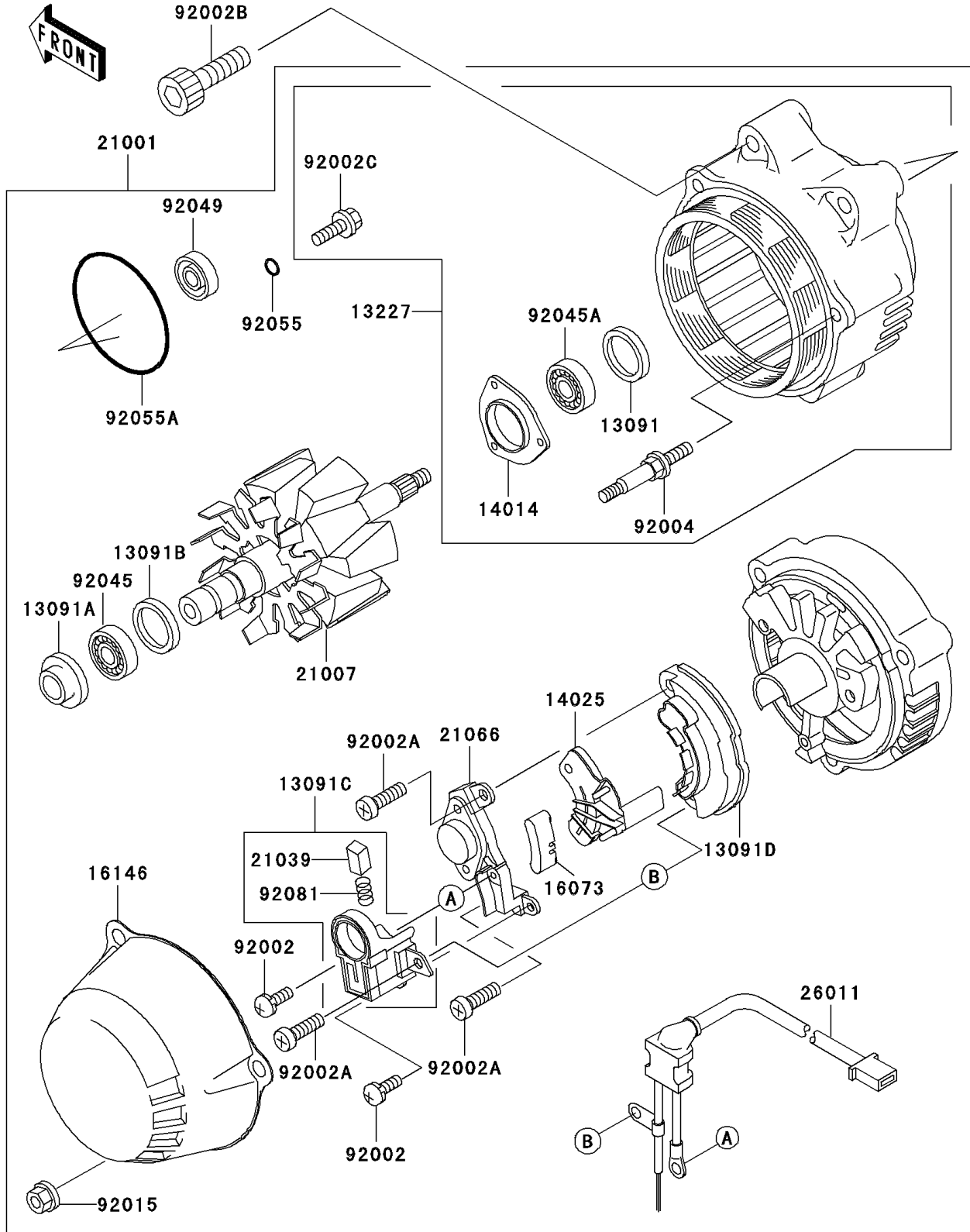

1995 Ninja® ZX™ -11 PARTS LIST

Generator

| ITEM NAME | PART NUMBER | QUANTITY |
|------------------------------------|-------------|----------|
| HOLDER,BEARING (Ref # 13091) | 13091-1326 | 1 |
| HOLDER,COVER (Ref # 13091A) | 13091-1327 | 1 |
| HOLDER,BEARING (Ref # 13091B) | 13091-1328 | 1 |
| HOLDER,BRUSH (Ref # 13091C) | 13091-1465 | 1 |
| RECTIFIER (Ref # 13091D) | 13091-1466 | 1 |
| HOUSING,GENERATOR (Ref # 13227) | 13227-1079 | 1 |
| PLATE-POSITION (Ref # 14014) | 14014-1065 | 1 |
| COVER,RECTIFIER (Ref # 14025) | 14025-1942 | 1 |
| INSULATOR (Ref # 16073) | 16073-1062 | 1 |
| COVER-ASSY,GENERATOR (Ref # 16146) | 16146-1074 | 1 |
| GENERATOR (Ref # 21001) | 21001-1104 | 1 |
| ROTOR,GENERATOR (Ref # 21007) | 21007-1196 | 1 |
| BRUSH,CARBON (Ref # 21039) | 21039-1052 | 2 |
| REGULATOR-VOLTAGE (Ref # 21066) | 21066-1076 | 1 |
| WIRE-LEAD,GENERATOR (Ref # 26011) | 26011-1432 | 1 |
| SCREW,4X8 (Ref # 92002) | 92002-1379 | 2 |
| SCREW,5X17.5 (Ref # 92002A) | 92002-1380 | 3 |
| BOLT,SOCKET,8X45 (Ref # 92002B) | 92002-1716 | 3 |
| BOLT (Ref # 92002C) | 92002-1856 | 3 |
| STUD (Ref # 92004) | 92004-1196 | 3 |
| NUT (Ref # 92015) | 92015-1800 | 3 |
| BEARING-BALL,#6002NC (Ref # 92045) | 92045-1133 | 1 |
| BEARING-BALL,#6002 (Ref # 92045A) | 92045-1185 | 1 |
| SEAL-OIL (Ref # 92049) | 92049-1200 | 1 |
| RING-O,3.5MM (Ref # 92055) | 92055-1264 | 3 |
| RING-O,70.6X2.4 (Ref # 92055A) | 92055-1366 | 1 |
| SPRING,BRUSH (Ref # 92081) | 92081-1759 | 2 |