

2023 TERYX® S LE PARTS DIAGRAM

Muffler(s)

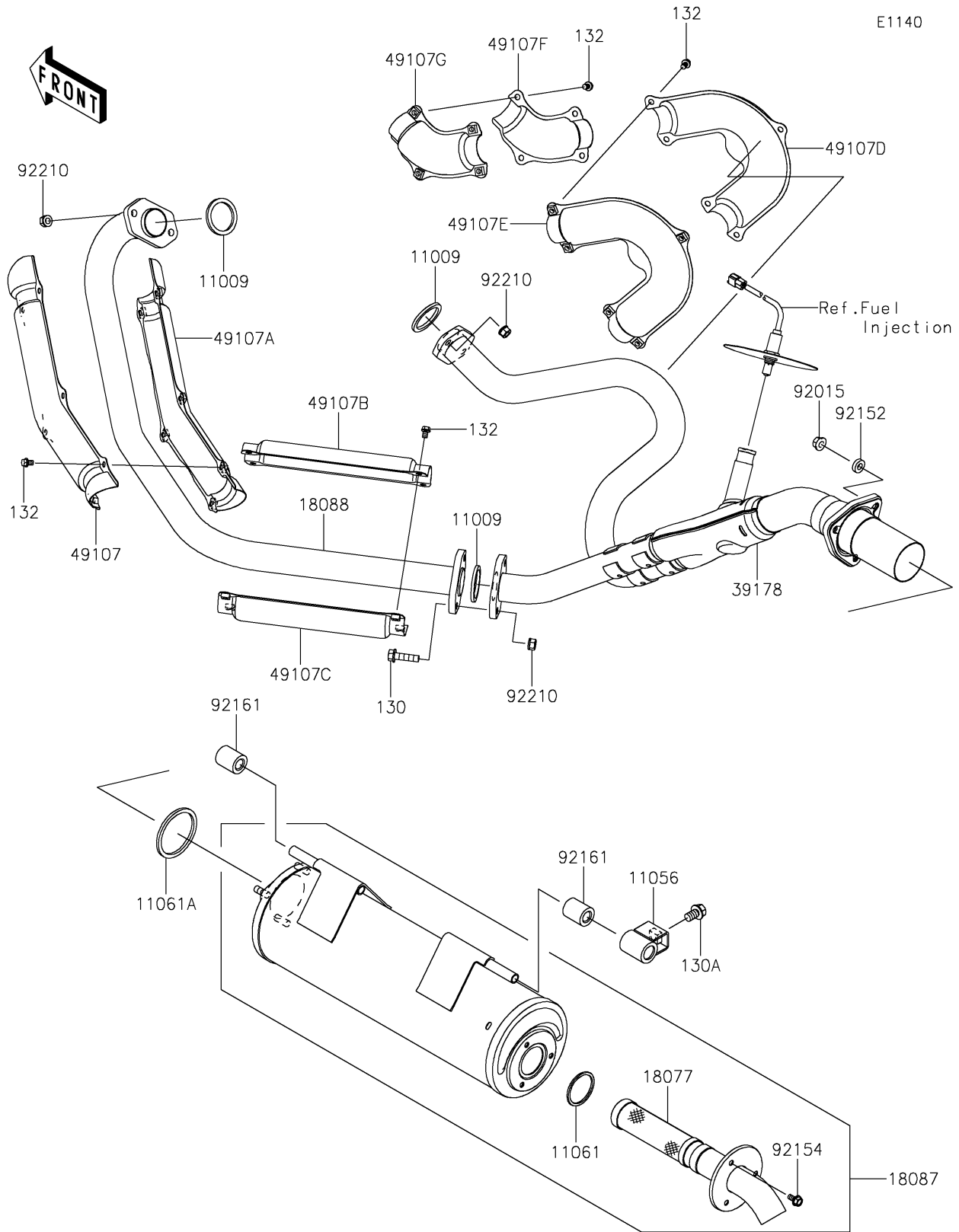

2023 TERYX® S LE PARTS LIST

Muffler(s)

ITEM NAME	PART NUMBER	QUANTITY
GASKET,EXHAUST PIPE (Ref # 11009)	11009-1992	3
BRACKET (Ref # 11056)	11056-0727	1
GASKET,38.9X46.4X3.0 (Ref # 11061)	11061-0082	1
GASKET,PIPE-MUFFLER (Ref # 11061A)	11061-0811	1
ARRESTER-SPARK (Ref # 18077)	18077-0036	1
MUFFLER (Ref # 18087)	18087-0326	1
PIPE-EXHAUST (Ref # 18088)	18088-0837	1
MANIFOLD-COMP-EXHAUST (Ref # 39178)	39178-0190	1
COVER-EXHAUST PIPE,FR,LH (Ref # 49107)	49107-0753	1
COVER-EXHAUST PIPE,FR,RH (Ref # 49107A)	49107-0754	1
COVER-EXHAUST PIPE,RR,UPP (Ref # 49107B)	49107-0755	1
COVER-EXHAUST PIPE,RR,LWR (Ref # 49107C)	49107-0756	1
COVER-EXHAUST MANIFOLD,RH (Ref # 49107D)	49107-0757	1
COVER-EXHAUST MANIFOLD,LH (Ref # 49107E)	49107-0758	1
COVER-EXHAUST PIPE,RH (Ref # 49107F)	49107-0797	1
COVER-EXHAUST PIPE,LH (Ref # 49107G)	49107-0798	1
NUT,8MM (Ref # 92015)	92015-1402	3
COLLAR,8.2X17X4.5 (Ref # 92152)	92152-1609	3
BOLT,FLANGED,6X12 (Ref # 92154)	92154-0852	3
DAMPER (Ref # 92161)	92161-0961	2
NUT,8MM (Ref # 92210)	92210-1242	6
BOLT-FLANGED,8X30 (Ref # 130)	130BD0830	2
BOLT-FLANGED,10X16 (Ref # 130A)	130CA1016	1
BOLT-FLANGED-SMALL,6X8 (Ref # 132)	132BD0608	19