

1995 Ninja® ZX™ -11 PARTS DIAGRAM

Brake Pedal/Torque Link

F2260

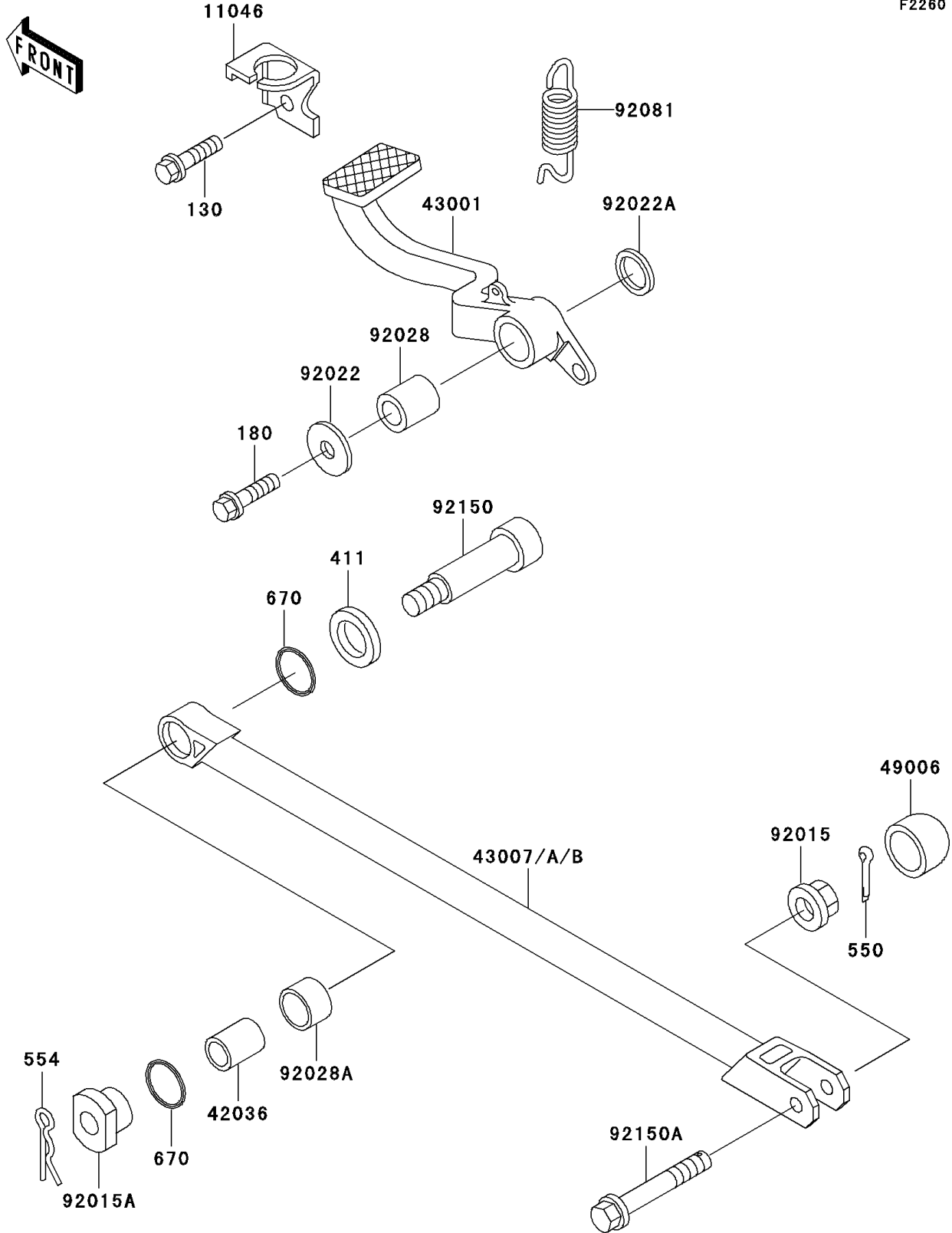

1995 Ninja® ZX™ -11 PARTS LIST

Brake Pedal/Torque Link

ITEM NAME	PART NUMBER	QUANTITY
BOLT-FLANGED,6X10 (Ref # 130)	130H0610	1
BOLT-UPSET-WS (Ref # 180)	180H0614	1
WASHER-PLAIN,10MM (Ref # 411)	411D1000	1
PIN-COTTER,2.0X15 (Ref # 550)	550D2015	1
PIN-SNAP,8MM (Ref # 554)	554A0800	1
O RING,16MM (Ref # 670)	670B2016	2
BRACKET,REAR BRAKE SWITCH (Ref # 11046)	11046-1252	1
SLEEVE,10.1X16X20 (Ref # 42036)	42036-1242	1
LEVER-BRAKE,PEDAL (Ref # 43001)	43001-1292	1
BOOT (Ref # 49006)	49006-1218	1
NUT,8MM (Ref # 92015)	92015-1432	1
NUT,8MM (Ref # 92015A)	92015-1747	1
WASHER,7X28X1.6 (Ref # 92022)	92022-1282	1
WASHER,15.3X24X1 (Ref # 92022A)	92022-326	1
BUSHING,BRAKE PEDAL (Ref # 92028)	92028-1282	1
BUSHING (Ref # 92028A)	92028-1468	1
SPRING,BRAKE PEDAL (Ref # 92081)	92081-1833	1
BOLT,SOCKET,8X61 (Ref # 92150)	92150-1167	1
BOLT,FLANGED,8X47 (Ref # 92150A)	92150-1539	1
ROD-TORQUE,G.GRAY (Ref # 43007)	43007-1165-GD	1
ROD-TORQUE,SILVER NO.35 (Ref # 43007B)	43007-1165-VZ	1