

2024 KLX® 300R PARTS DIAGRAM

Engine Cover(s)

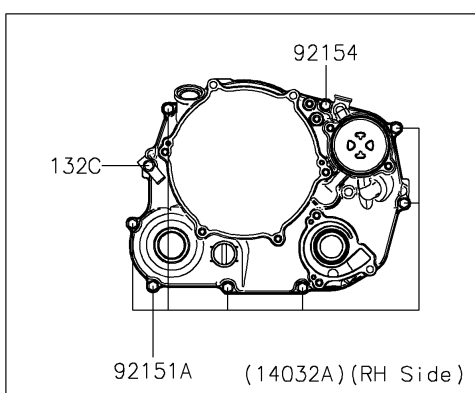
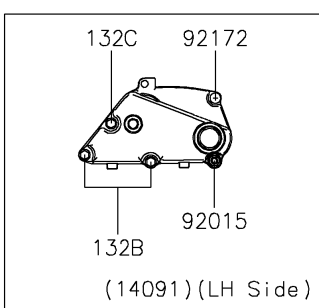
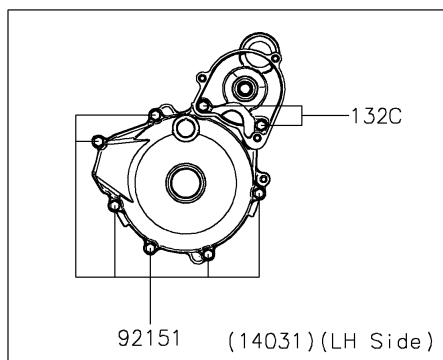
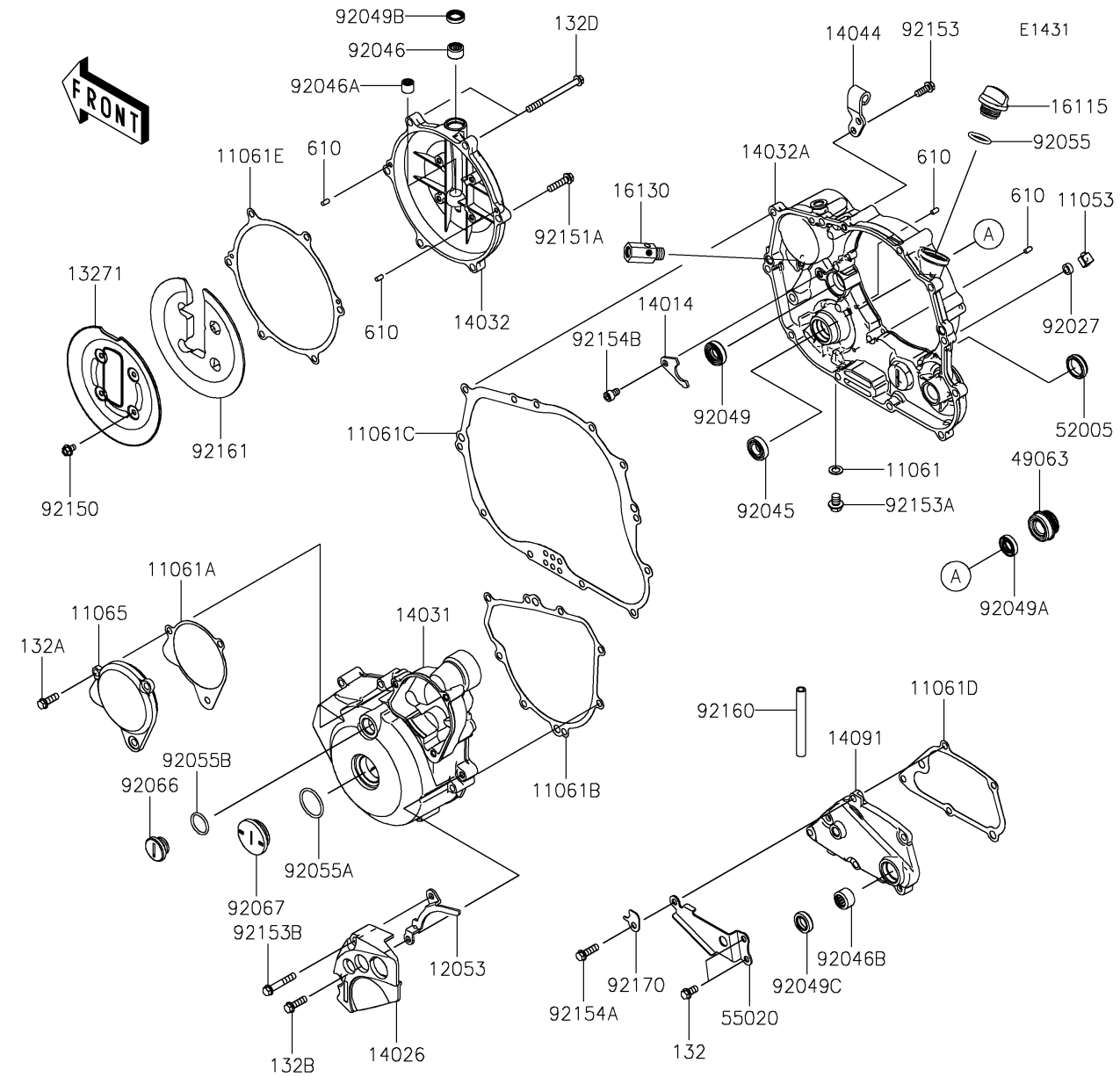

2024 KLX®300R PARTS LIST

Engine Cover(s)

ITEM NAME	PART NUMBER	QUANTITY
BRACKET (Ref # 11053)	11053-1656	1
GASKET,8.2X14X1.0 (Ref # 11061)	11061-0418	1
GASKET,CAP (Ref # 11061A)	11061-1475	1
GASKET,GENERATOR COVER (Ref # 11061B)	11061-1476	1
GASKET,CLUTCH COVER INNER (Ref # 11061C)	11061-1477	1
GASKET,TRANSMISSION COVER (Ref # 11061D)	11061-1479	1
GASKET,CLUTCH COVER OUTER (Ref # 11061E)	11061-1507	1
CAP,GENERATOR COVER (Ref # 11065)	11065-0274	1
GUIDE-CHAIN (Ref # 12053)	12053-1337	1
PLATE (Ref # 13271)	13271-1567	1
PLATE-POSITION (Ref # 14014)	14014-0567	1
COVER-CHAIN (Ref # 14026)	14026-0027	1
COVER-GENERATOR (Ref # 14031)	14031-0110	1
COVER-CLUTCH,OUTER (Ref # 14032)	14032-0004	1
COVER-CLUTCH (Ref # 14032A)	14032-0658	1
HOLDER-CABLE (Ref # 14044)	14044-1078	1
COVER (Ref # 14091)	14091-0019	1
CAP-OIL FILLER (Ref # 16115)	16115-1053	1
VALVE-ASSY-RELIEF (Ref # 16130)	16130-0002	1
SEAL-MECHANICAL (Ref # 49063)	49063-1055	1
GAUGE,OIL LEVEL (Ref # 52005)	52005-1009	1
GUARD,TRANSMISSION COVER (Ref # 55020)	55020-1460	1
NUT,FLANGED,6MM (Ref # 92015)	92015-1367	1
COLLAR,6.5X10.5X4.5 (Ref # 92027)	92027-1885	1
BEARING-BALL,6901 (Ref # 92045)	92045-1246	1
BEARING-NEEDLE,HK1210FM (Ref # 92046)	92046-0034	1
BEARING-NEEDLE (Ref # 92046A)	92046-0042	1
BEARING-NEEDLE,HK1312 (Ref # 92046B)	92046-1148	1
SEAL-OIL (Ref # 92049)	92049-1191	1

2024 KLX®300R PARTS LIST

Engine Cover(s)

ITEM NAME	PART NUMBER	QUANTITY
SEAL-OIL,SC 12X22X5 (Ref # 92049A)	92049-1228	1
SEAL-OIL,AG0353-F0 (Ref # 92049B)	92049-1262	1
SEAL-OIL (Ref # 92049C)	92049-1559	1
RING-O (Ref # 92055)	92055-012	1
RING-O,27.7X2.4 (Ref # 92055A)	92055-091	1
RING-O,20X2 (Ref # 92055B)	92055-1146	1
PLUG,COVER (Ref # 92066)	92066-0011	1
PLUG,30X8 (Ref # 92067)	92067-024	1
BOLT,5X8 (Ref # 92150)	92150-1406	4
BOLT,6X40 (Ref # 92151)	92151-1131	6
BOLT,FLANGED-SMALL,6X25 (Ref # 92151A)	92151-1930	11
BOLT,6X16 (Ref # 92153)	92153-0695	2
BOLT,FLANGED,8X10 (Ref # 92153A)	92153-1342	1
BOLT,FLANGED,6X35 (Ref # 92153B)	92153-1351	1
BOLT,FLANGED,6X25 (Ref # 92154)	92154-0490	1
BOLT,FLANGED,6X20 (Ref # 92154A)	92154-3945	1
BOLT,SOCKET,6X10 (Ref # 92154B)	92154-4072	1
DAMPER (Ref # 92160)	92160-1866	1
DAMPER (Ref # 92161)	92161-1182	1
CLAMP (Ref # 92170)	92170-1785	1
SCREW,6X16 (Ref # 92172)	92172-0223	1
BOLT-FLANGED-SMALL,6X12 (Ref # 132)	132BC0612	2
BOLT-FLANGED-SMALL,6X18 (Ref # 132A)	132BC0618	3
BOLT-FLANGED-SMALL,6X20 (Ref # 132B)	132BC0620	3
BOLT-FLANGED-SMALL,6X30 (Ref # 132C)	132BC0630	4
BOLT-FLANGED-SMALL,6X70 (Ref # 132D)	132BC0670	2
ROLLER,4X8 (Ref # 610)	610A0408	4