

2025 MULE SX™ 4x4 PARTS DIAGRAM

Frame Fittings(Rear)

F2131

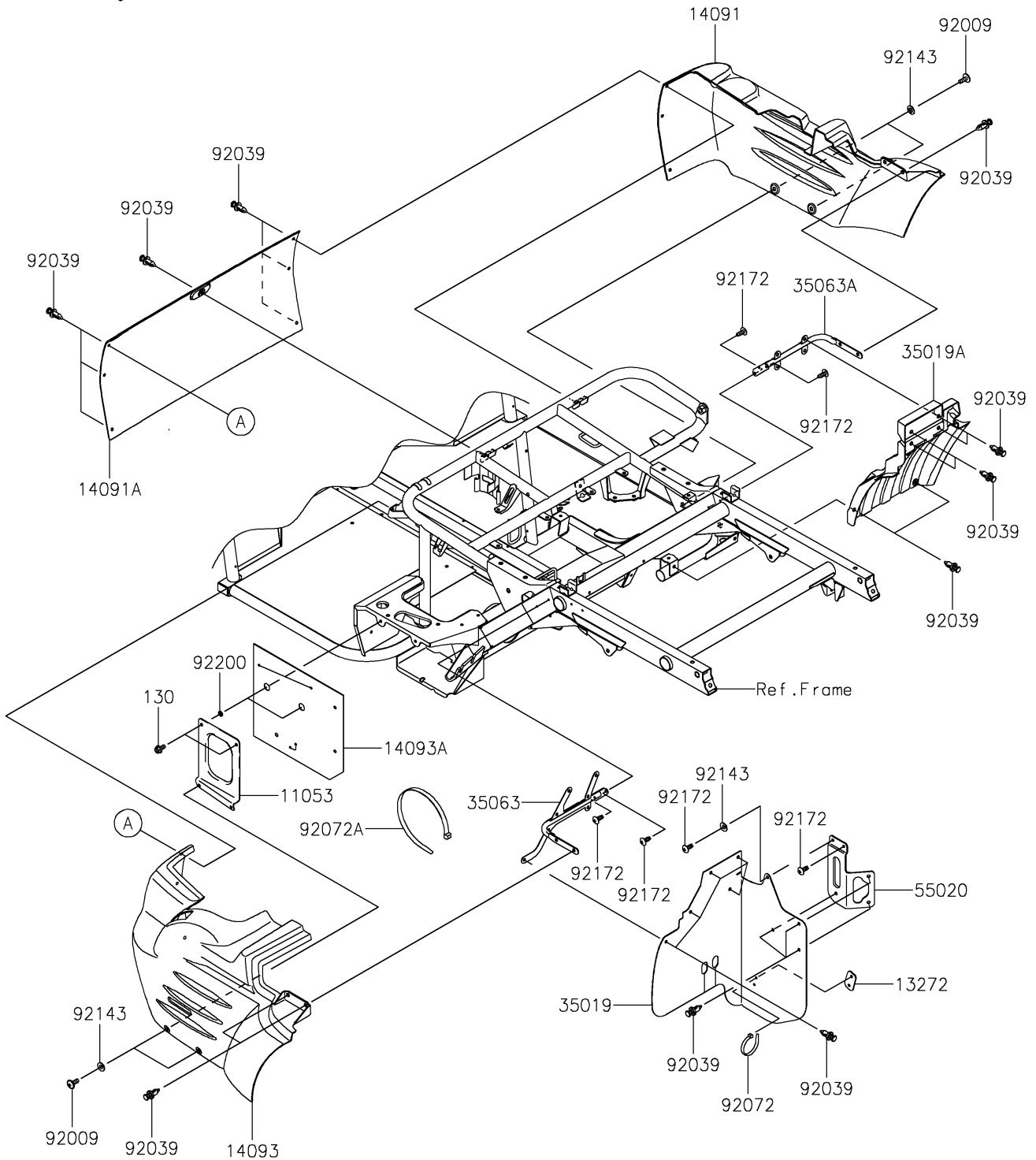

2025 MULE SX™ 4x4 PARTS LIST

Frame Fittings(Rear)

ITEM NAME	PART NUMBER	QUANTITY
BRACKET (Ref # 11053)	11053-0857	1
PLATE (Ref # 13272)	13272-7516	1
COVER,REAR SIDE,RH,F.BLACK (Ref # 14091)	14091-0224-6Z	1
COVER,UNDER SEAT,CNT,F.BLACK (Ref # 14091A)	14091-0341-6Z	1
COVER,REAR SIDE,LH,F.BLACK (Ref # 14093)	14093-0500-6Z	1
COVER,BATTERY (Ref # 14093A)	14093-0750	1
FLAP,SIDE COVER,LH (Ref # 35019)	35019-0610	1
FLAP,SIDE COVER,RH (Ref # 35019A)	35019-0612	1
STAY,LH (Ref # 35063)	35063-0784	1
STAY,RH (Ref # 35063A)	35063-1333	1
GUARD,COOLING FAN (Ref # 55020)	55020-7527	1
SCREW,6X16 (Ref # 92009)	92009-1621	4
RIVET (Ref # 92039)	92039-0776	25
BAND,L=188 (Ref # 92072)	92072-1239	1
BAND,L=368.3 (Ref # 92072A)	92072-3872	1
COLLAR (Ref # 92143)	92143-1087	5
SCREW,TAPPING,6X16 (Ref # 92172)	92172-0739	6
WASHER,7.2X14.3X1.6 (Ref # 92200)	92200-2207	2
BOLT-FLANGED,6X12 (Ref # 130)	130BA0612	2