

2025 MULE SX™ 4x4 PARTS DIAGRAM

Rear Fender(s)

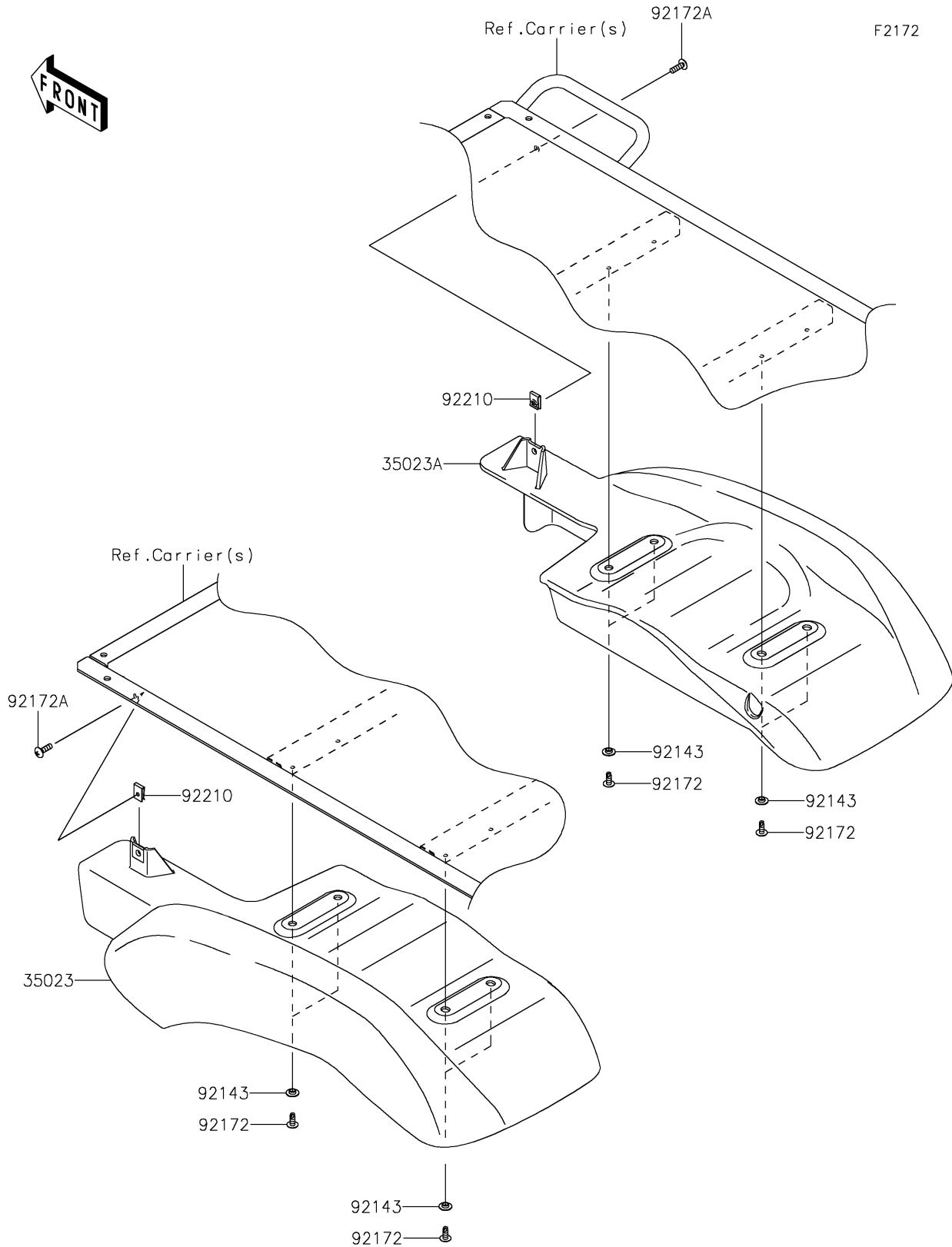

2025 MULE SX™ 4x4 PARTS LIST

Rear Fender(s)

ITEM NAME	PART NUMBER	QUANTITY
FENDER-REAR,LH,F.BLACK (Ref # 35023)	35023-0045-6Z	1
FENDER-REAR,RH,F.BLACK (Ref # 35023A)	35023-0046-6Z	1
COLLAR (Ref # 92143)	92143-1087	8
SCREW,TAPPING,6X16 (Ref # 92172)	92172-0739	8
SCREW,TAPPING,6X20 (Ref # 92172A)	92172-0883	2
NUT,LEAF SPRING,6MM (Ref # 92210)	92210-0624	2