

# 1997 Ninja® ZX™ -11 PARTS DIAGRAM

Ignition Switch/Locks/Reflectors

F2770

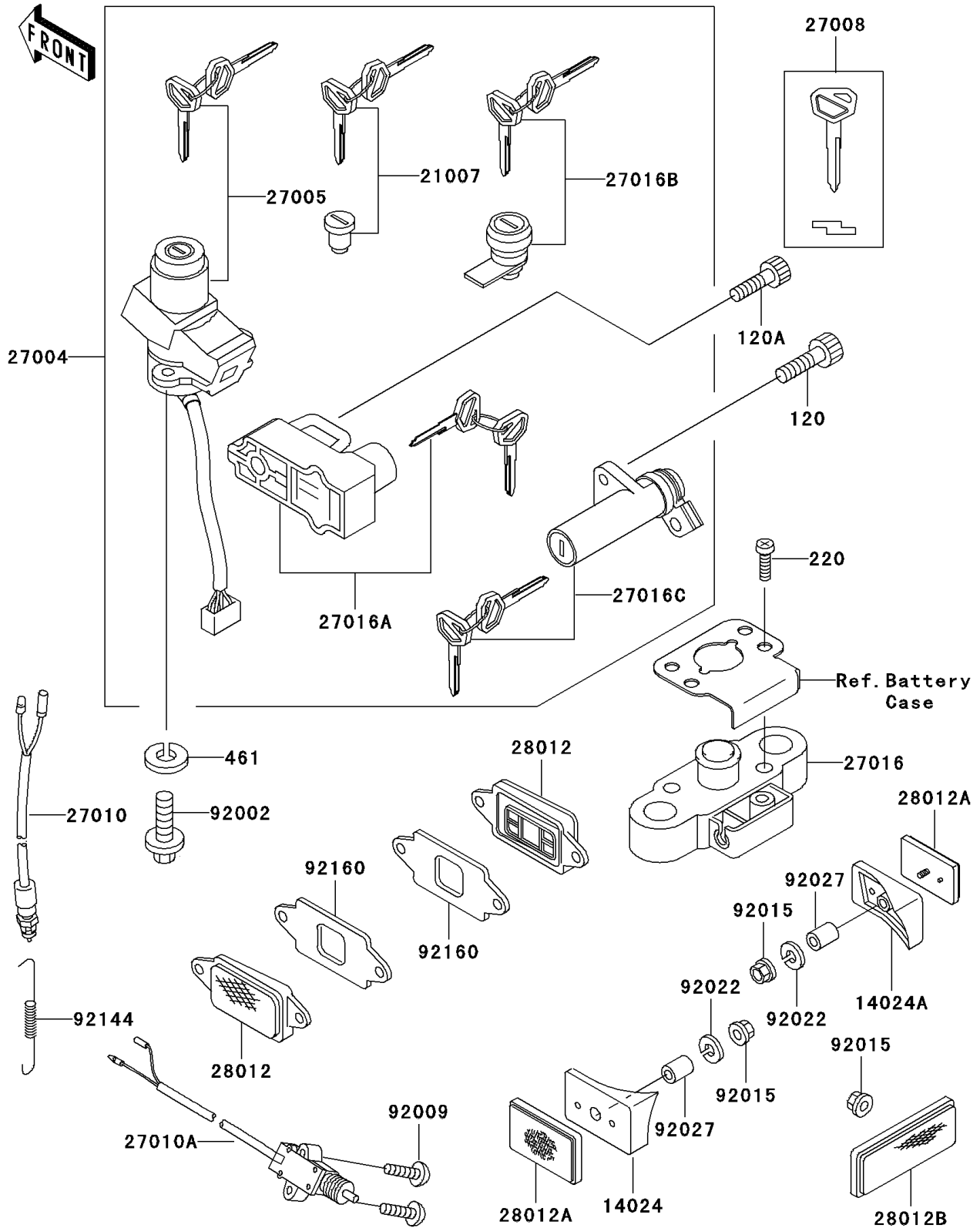

# 1997 Ninja® ZX™ -11 PARTS LIST

## Ignition Switch/Locks/Reflectors

ITEM NAME	PART NUMBER	QUANTITY
BOLT-SOCKET (Ref # 120)	120S0512	2
BOLT-SOCKET,6X16,BLACK (Ref # 120A)	120S0616	1
SCREW-PAN-CROS,6X30,BLACK (Ref # 220)	220C0630	2
WASHER-SPRING (Ref # 461)	461L0600	2
COVER,REFLECTOR,LH (Ref # 14024)	14024-1940	1
COVER,REFLECTOR,RH (Ref # 14024A)	14024-1941	1
ROTOR,LOCK,TANK CAP (Ref # 21007)	21007-5037	1
SWITCH-ASSY (Ref # 27004)	27004-5452	1
SWITCH-ASSY-IGNITION (Ref # 27005)	27005-5101	1
KEY-LOCK,BLANK (Ref # 27008)	27008-1173	1
SWITCH,BRAKE LAMP (Ref # 27010)	27010-1093	1
SWITCH,SIDE STAND (Ref # 27010A)	27010-1226	1
LOCK-ASSY,SEAT STRIKER (Ref # 27016)	27016-1098	1
LOCK-ASSY,HELMET (Ref # 27016A)	27016-5203	1
LOCK-ASSY,TOOL BOX (Ref # 27016B)	27016-5204	1
LOCK-ASSY,SEAT (Ref # 27016C)	27016-5205	1
REFLECTOR-REFLEX,FR,SIDE (Ref # 28012)	28012-1068	2
REFLECTOR-REFLEX,RR (Ref # 28012A)	28012-1072	2
REFLECTOR-REFLEX (Ref # 28012B)	28012-1077	1
BOLT,TORX,6X16 (Ref # 92002)	92002-1333	2
SCREW,5X20 (Ref # 92009)	92009-1459	2
NUT,FLANGED,5MM (Ref # 92015)	92015-1259	3
WASHER,5.2X16X1.2 (Ref # 92022)	92022-263	2
COLLAR,5X8X14.5 (Ref # 92027)	92027-1789	2
SPRING,REAR BRAKE SWITCH (Ref # 92144)	92144-1283	1
DAMPER,REFLECTOR (Ref # 92160)	92160-1192	2