

# 2000 Ninja® ZX™-11 PARTS DIAGRAM

Starter Motor

E1840

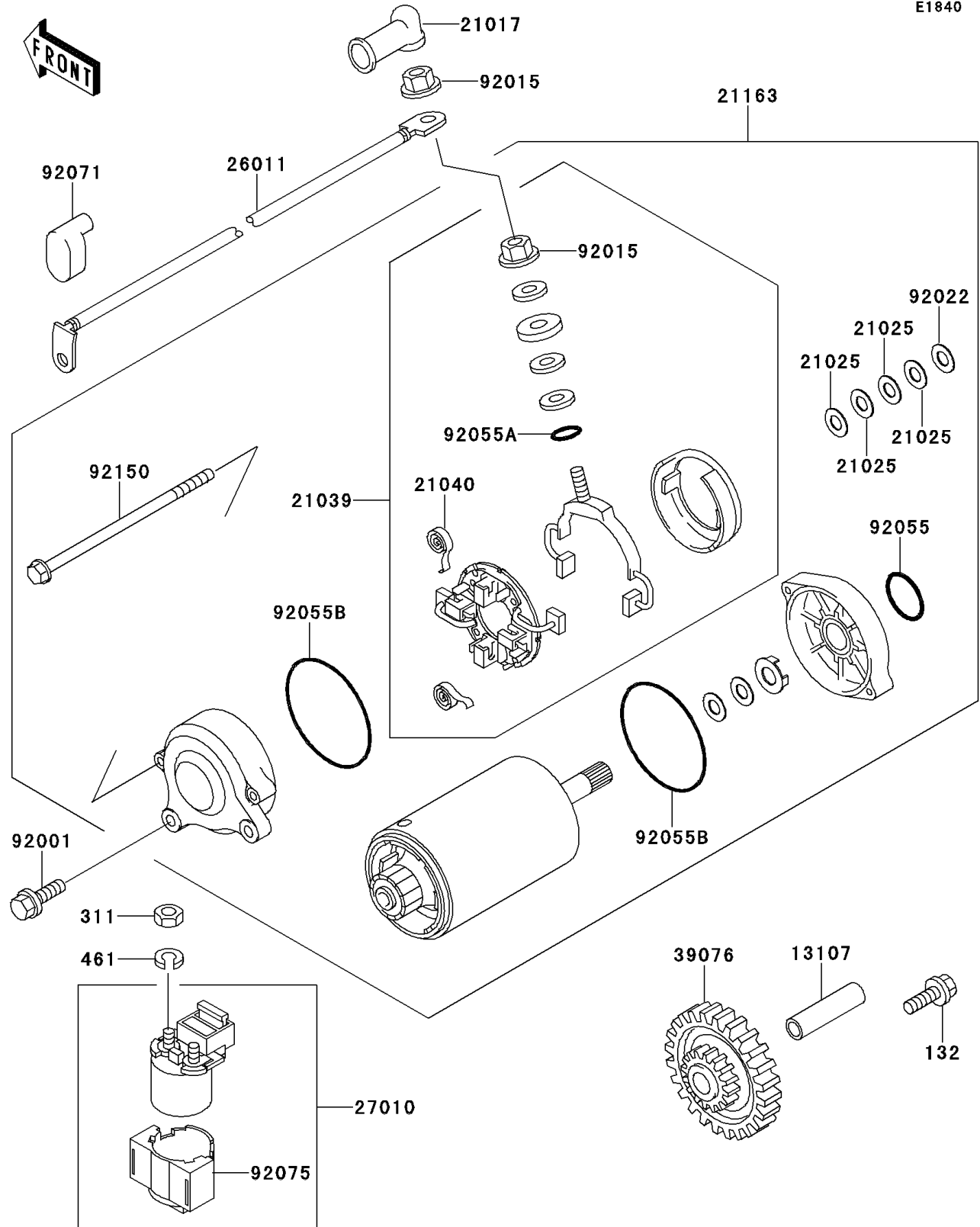

## 2000 Ninja® ZX™-11 PARTS LIST

### Starter Motor

ITEM NAME	PART NUMBER	QUANTITY
BOLT-FLANGED-SMALL (Ref # 132)	132G0612	1
NUT-HEX,6MM (Ref # 311)	311B0600	2
WASHER-SPRING,6MM (Ref # 461)	461F0600	2
SHAFT,IDLE GEAR (Ref # 13107)	13107-1106	1
GROMMET,STARTER TERMINAL (Ref # 21017)	21017-017	1
WASHER,9.1X18X0.2 (Ref # 21025)	21025-011	4
BRUSH,CARBON (Ref # 21039)	21039-1060	1
SPRING-BRUSH (Ref # 21040)	21040-1055	4
STARTER-ELECTRIC (Ref # 21163)	21163-1212	1
WIRE-LEAD,STARTER MOTOR (Ref # 26011)	26011-1479	1
SWITCH,MAGNETIC (Ref # 27010)	27010-1254	1
LIMITER,STARTER IDLE GEAR (Ref # 39076)	39076-1061	1
BOLT,6X20 (Ref # 92001)	92001-1947	2
NUT,STARTER MOTOR (Ref # 92015)	92015-1476	2
WASHER,9.1X18X0.8 (Ref # 92022)	92022-1132	1
RING-O (Ref # 92055)	92055-1276	1
RING-O,4.5X2.0 (Ref # 92055A)	92055-1370	1
RING-O,STARTER MOTOR (Ref # 92055B)	92055-1381	2
GROMMET,TERMINAL (Ref # 92071)	92071-1130	1
DAMPER,MAGNETIC SWITCH (Ref # 92075)	92075-1863	1
BOLT (Ref # 92150)	92150-1693	2