

2001 Ninja® ZX™-11 PARTS DIAGRAM

Radiator

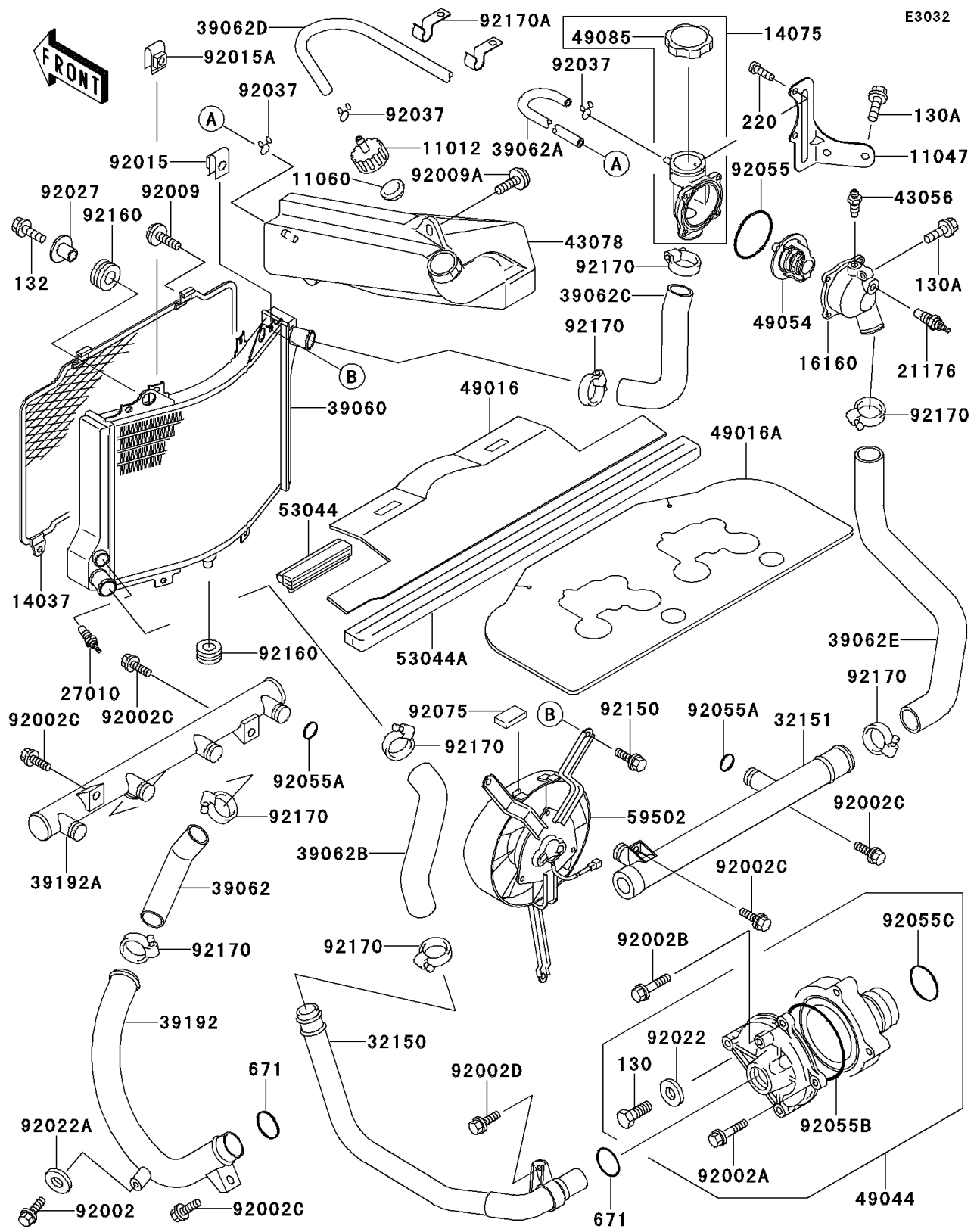

2001 Ninja® ZX™-11 PARTS LIST

Radiator

ITEM NAME	PART NUMBER	QUANTITY
CAP (Ref # 11012)	11012-1854	1
BRACKET,THERMOSTAT BODY (Ref # 11047)	11047-1887	1
GASKET,RESERVOIR TANK CAP (Ref # 11060)	11060-1349	1
SCREEN,RADIATOR (Ref # 14037)	14037-1172	1
CAP-ASSY (Ref # 14075)	14075-1068	1
BODY,THERMOSTAT,LWR (Ref # 16160)	16160-1117	1
SENSOR,WATER (Ref # 21176)	21176-1054	1
SWITCH,FAN (Ref # 27010)	27010-1202	1
PIPE (Ref # 32150)	32150-1483	1
PIPE,CYLINDER HEAD (Ref # 32151)	32151-1359	1
RADIATOR (Ref # 39060)	39060-1116	1
HOSE-COOLING,PUMP-CYLINDER (Ref # 39062)	39062-1276	1
HOSE-COOLING,RESERVOIR (Ref # 39062A)	39062-1285	1
HOSE-COOLING (Ref # 39062B)	39062-1377	1
HOSE-COOLING,THERMO-RADIATOR (Ref # 39062C)	39062-1531	1
HOSE-COOLING,OVERFLOW (Ref # 39062D)	39062-1533	1
HOSE-COOLING,HEAD-THERMOSTAT (Ref # 39062E)	39062-1542	1
PIPE-WATER,PUMP-CYLINDER (Ref # 39192)	39192-1011	1
PIPE-WATER,CYLINDER (Ref # 39192A)	39192-1031	1
BREATHER (Ref # 43056)	43056-003	1
RESERVOIR (Ref # 43078)	43078-1131	1
COVER-SEAL (Ref # 49016)	49016-1165	1
COVER-SEAL (Ref # 49016A)	49016-1166	1
PUMP-WATER (Ref # 49044)	49044-1076	1
THERMOSTAT (Ref # 49054)	49054-1051	1
CAP-ASSY-PRESSURE (Ref # 49085)	49085-1067	1
TRIM (Ref # 53044)	53044-1220	4
TRIM,RADIATOR PLATE,OUTER (Ref # 53044A)	53044-1269	1
FAN-ASSY (Ref # 59502)	59502-1105	1

2001 Ninja® ZX™-11 PARTS LIST

Radiator

ITEM NAME	PART NUMBER	QUANTITY
BOLT,6X16 (Ref # 92002)	92002-1099	1
BOLT,6X22 (Ref # 92002A)	92002-1392	2
BOLT,6X40 (Ref # 92002B)	92002-1566	2
BOLT,6X12 (Ref # 92002C)	92002-1569	5
BOLT,6X16 (Ref # 92002D)	92002-1571	1
SCREW,TAPPING,6MM (Ref # 92009)	92009-1261	4
SCREW,6X18 (Ref # 92009A)	92009-1663	2
NUT (Ref # 92015)	92015-1487	3
NUT,6MM (Ref # 92015A)	92015-1758	4
WASHER,6MM (Ref # 92022)	92022-1976	1
WASHER,6.2X11X1 (Ref # 92022A)	92022-304	1
BOLT-FLANGED,6X10,BLACK (Ref # 130)	130C0610	1
BOLT-FLANGED,6X12 (Ref # 130A)	130G0612	3
BOLT-FLANGED-SMALL (Ref # 132)	132J0825	2
SCREW-PAN-CROS,5X14 (Ref # 220)	220D0514	4
O RING,25MM (Ref # 671)	671B2525	2
COLLAR,L=14 (Ref # 92027)	92027-1134	2
CLAMP,TUBE (Ref # 92037)	92037-147	3
RING-O,53.5X2.6 (Ref # 92055)	92055-112	1
RING-O (Ref # 92055A)	92055-1282	6
RING-O,WATER PUMP INSIDE (Ref # 92055B)	92055-1423	1
RING-O,33.2X2.4 (Ref # 92055C)	92055-1424	1
DAMPER (Ref # 92075)	92075-1446	2
BOLT,6X12 (Ref # 92150)	92150-1186	3
DAMPER (Ref # 92160)	92160-1007	3
CLAMP,COOLING HOSE (Ref # 92170)	92170-1284	8
CLAMP,COOLING HOSE (Ref # 92170A)	92170-1391	2