

2024 Vulcan 900 Classic LT PARTS DIAGRAM

Chassis Electrical Equipment

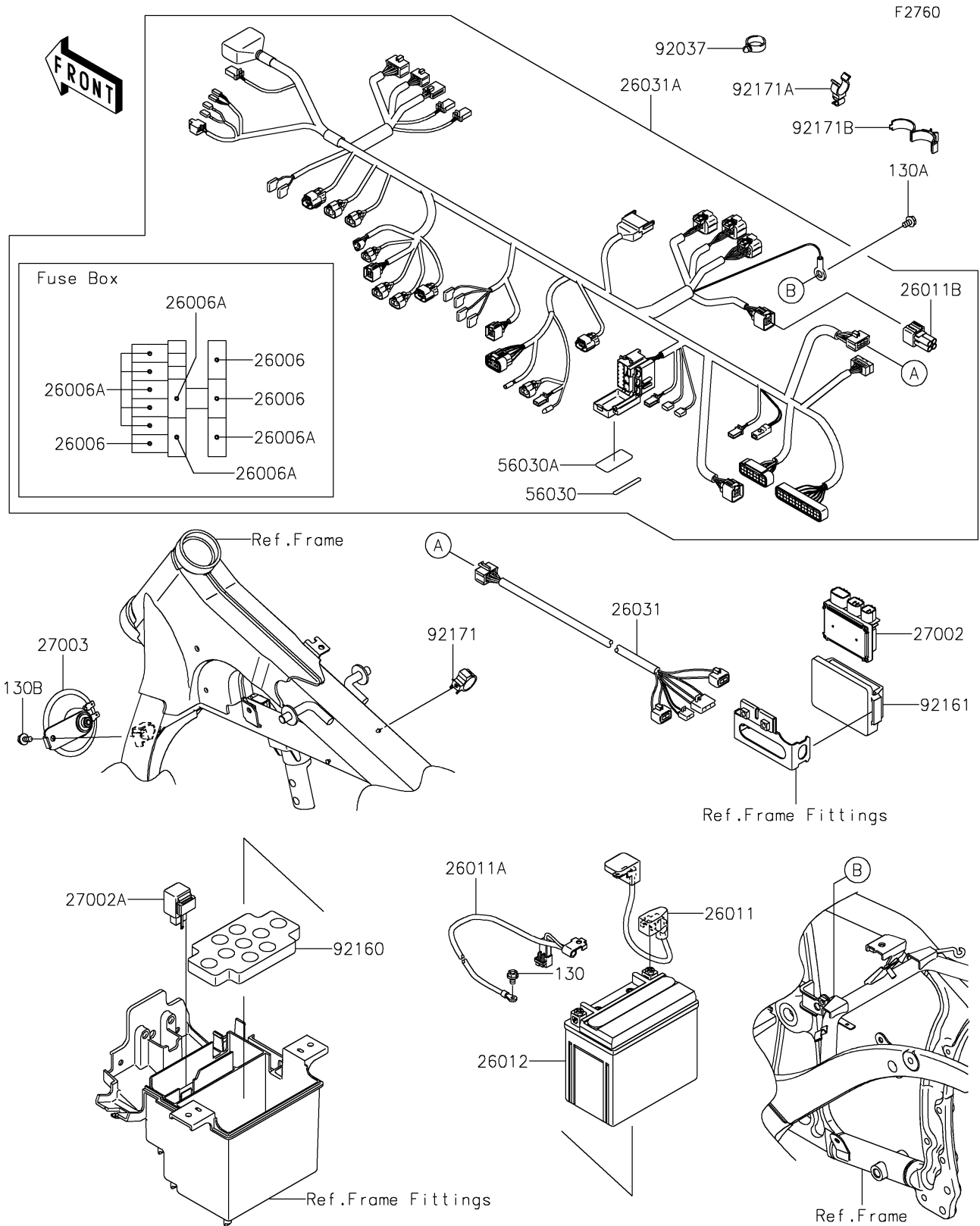

2024 Vulcan 900 Classic LT PARTS LIST

Chassis Electrical Equipment

ITEM NAME	PART NUMBER	QUANTITY
FUSE,MINI BLADE,15A,BLUE (Ref # 26006)	26006-0001	3
FUSE,MINI BLADE,10A,RED (Ref # 26006A)	26006-1078	8
WIRE-LEAD,BATTERY(+) (Ref # 26011)	26011-0089	1
WIRE-LEAD,BATTERY(-) (Ref # 26011A)	26011-0090	1
WIRE-LEAD,CAP (Ref # 26011B)	26011-0271	1
BATTERY,YTX12-BS,12V 10AH (Ref # 26012)	26012-1514	1
HARNESS,RR (Ref # 26031)	26031-2233	1
HARNESS,MAIN (Ref # 26031A)	26031-2234	1
RELAY-ASSY (Ref # 27002)	27002-0050	1
RELAY-ASSY,TURN SIGNAL (Ref # 27002A)	27002-1101	1
HORN (Ref # 27003)	27003-0039	1
LABEL,FUSE BOX (Ref # 56030)	56030-0016	1
LABEL,FUSE BOX (Ref # 56030A)	56030-0046	1
CLAMP,HOSE (Ref # 92037)	92037-1827	1
DAMPER,BATTERY (Ref # 92160)	92160-1635	1
DAMPER,RELAY BOX (Ref # 92161)	92161-0203	1
CLAMP,20MM DIA. (Ref # 92171)	92171-0081	1
CLAMP,CABLE (Ref # 92171A)	92171-0347	1
CLAMP,10MM DIA. (Ref # 92171B)	92171-1423	1
BOLT-FLANGED,6X10 (Ref # 130)	130BA0610	1
BOLT-FLANGED,6X10 (Ref # 130A)	130BB0610	1
BOLT-FLANGED,6X12 (Ref # 130B)	130BB0612	1