

# 2023 VULCAN® 900 CLASSIC LT PARTS DIAGRAM

Cowling

F2871

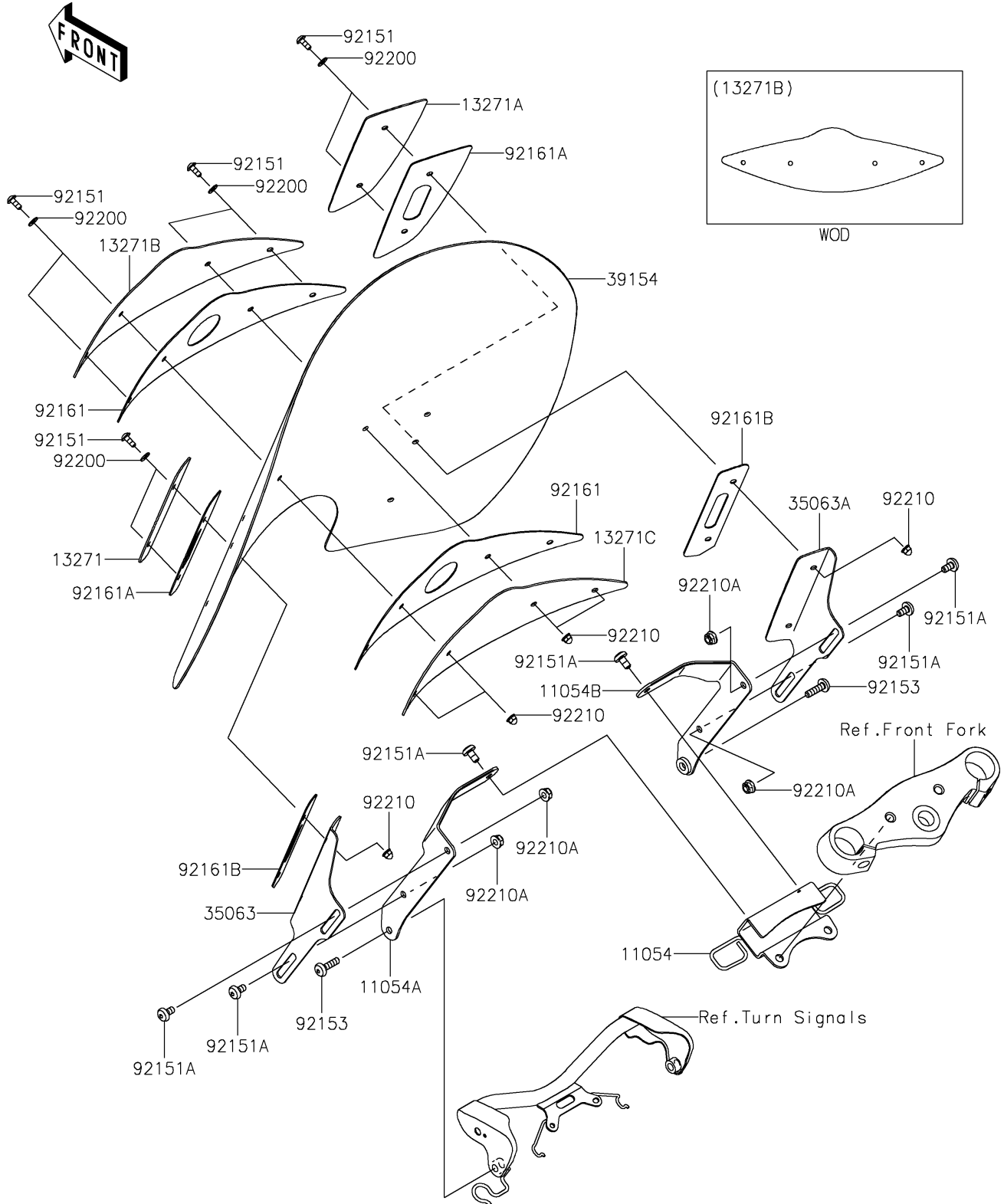

## 2023 VULCAN® 900 CLASSIC LT PARTS LIST

### Cowling

ITEM NAME	PART NUMBER	QUANTITY
BRACKET,CNT (Ref # 11054)	11054-0787	1
BRACKET,LH (Ref # 11054A)	11054-0789	1
BRACKET,RH (Ref # 11054B)	11054-0791	1
PLATE,WINDSHIELD,LH,OUTER (Ref # 13271)	13271-0704	1
PLATE,WINDSHIELD,RH,OUTER (Ref # 13271A)	13271-0705	1
PLATE,WINDSHIELD,CNT,OUTER (Ref # 13271B)	13271-0706	1
PLATE,WINDSHIELD,CNT,INNER (Ref # 13271C)	13271-0707	1
STAY,WINDSHIELD,LH (Ref # 35063)	35063-0267	1
STAY,WINDSHIELD,RH (Ref # 35063A)	35063-0268	1
WINDSHIELD (Ref # 39154)	39154-0018	1
BOLT,SOCKET,6X16 (Ref # 92151)	92151-1751	8
BOLT,SOCKET,8X16 (Ref # 92151A)	92151-1752	6
BOLT,SOCKET,8X30 (Ref # 92153)	92153-1467	2
DAMPER,WINDSHIELD,CNT (Ref # 92161)	92161-0330	2
DAMPER,WINDSHIELD,LH&RH,OUTER (Ref # 92161A)	92161-0332	2
DAMPER,WINDSHIELD,LH&RH,INNER (Ref # 92161B)	92161-0382	2
WASHER,6.5X14.5X1.5 (Ref # 92200)	92200-3775	8
NUT,CAP,6MM (Ref # 92210)	92210-0322	8
NUT,LOCK,FLANGED,8MM (Ref # 92210A)	92210-0330	4