

# 2023 VULCAN® 1700 VOYAGER® ABS PARTS DIAGRAM

Cylinder Head

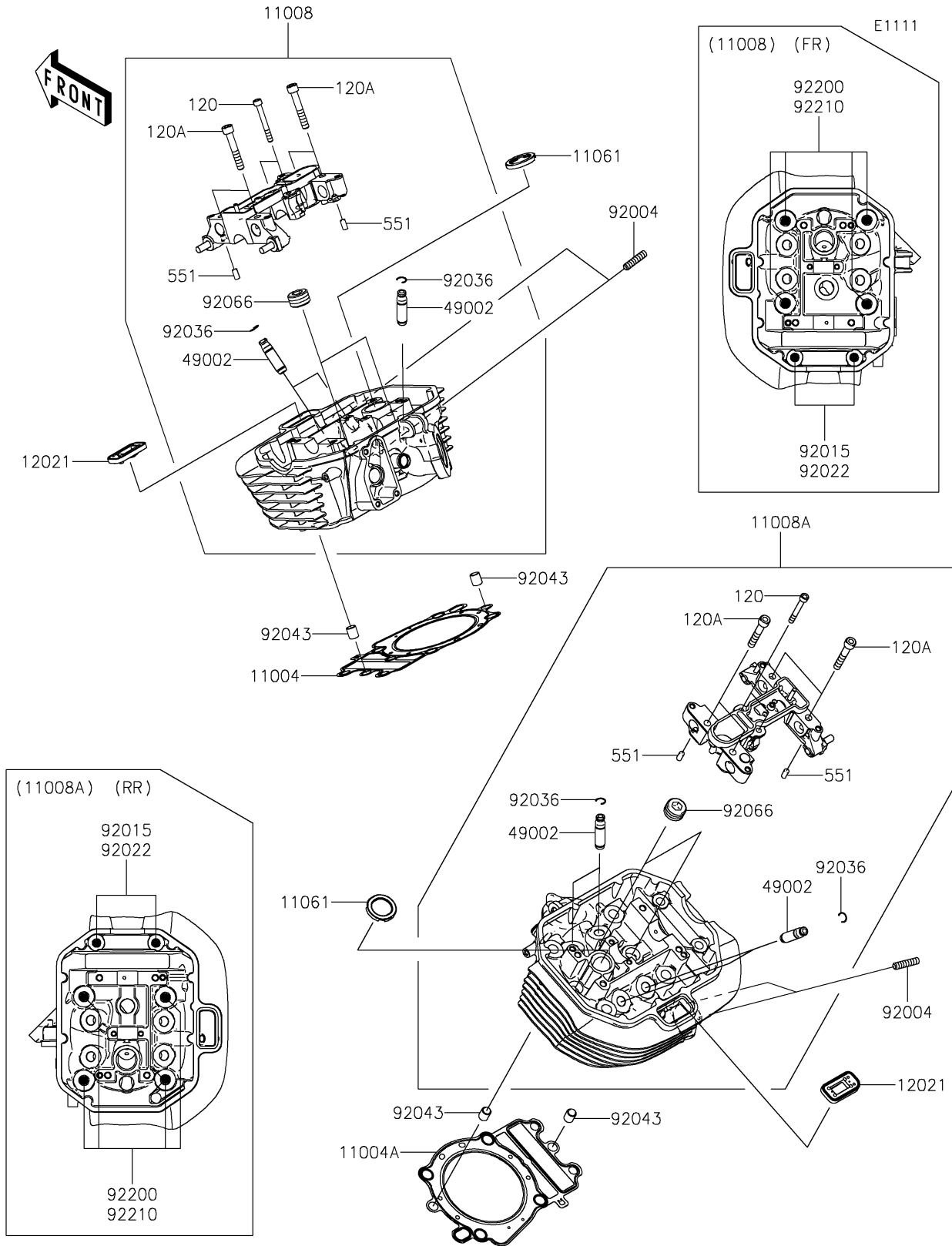

## 2023 VULCAN® 1700 VOYAGER® ABS PARTS LIST

### Cylinder Head

ITEM NAME	PART NUMBER	QUANTITY
GASKET-HEAD,FR (Ref # 11004)	11004-0076	1
GASKET-HEAD,RR (Ref # 11004A)	11004-0077	1
HEAD-COMP-CYLINDER,FR (Ref # 11008)	11008-0922	1
HEAD-COMP-CYLINDER,RR (Ref # 11008A)	11008-0924	1
GASKET,PLUG HOLE (Ref # 11061)	11061-0409	2
VALVE-ASSY-REED (Ref # 12021)	12021-0017	2
GUIDE-VALVE (Ref # 49002)	49002-0707	8
STUD,8X20 (Ref # 92004)	92004-0046	4
NUT,FLANGED,10MM (Ref # 92015)	92015-077	4
WASHER,10.2X20X1.5 (Ref # 92022)	92022-3742	4
RING-SNAP,VALVE GUIDE (Ref # 92036)	92036-023	8
PIN,12X14 (Ref # 92043)	92043-0963	4
PLUG,PT1/2X12.5 (Ref # 92066)	92066-0002	4
WASHER,12.3X25X3.2 (Ref # 92200)	92200-0422	8
NUT,12MM (Ref # 92210)	92210-0546	8
BOLT-SOCKET,6X50 (Ref # 120)	120Q0650	4
BOLT-SOCKET,8X50 (Ref # 120A)	120Q0850	8
PIN-DOWEL,6X12 (Ref # 551)	551A0612	4