

# 2022 Z H2 SE PARTS DIAGRAM

Camshaft(s)/Tensioner

E1230

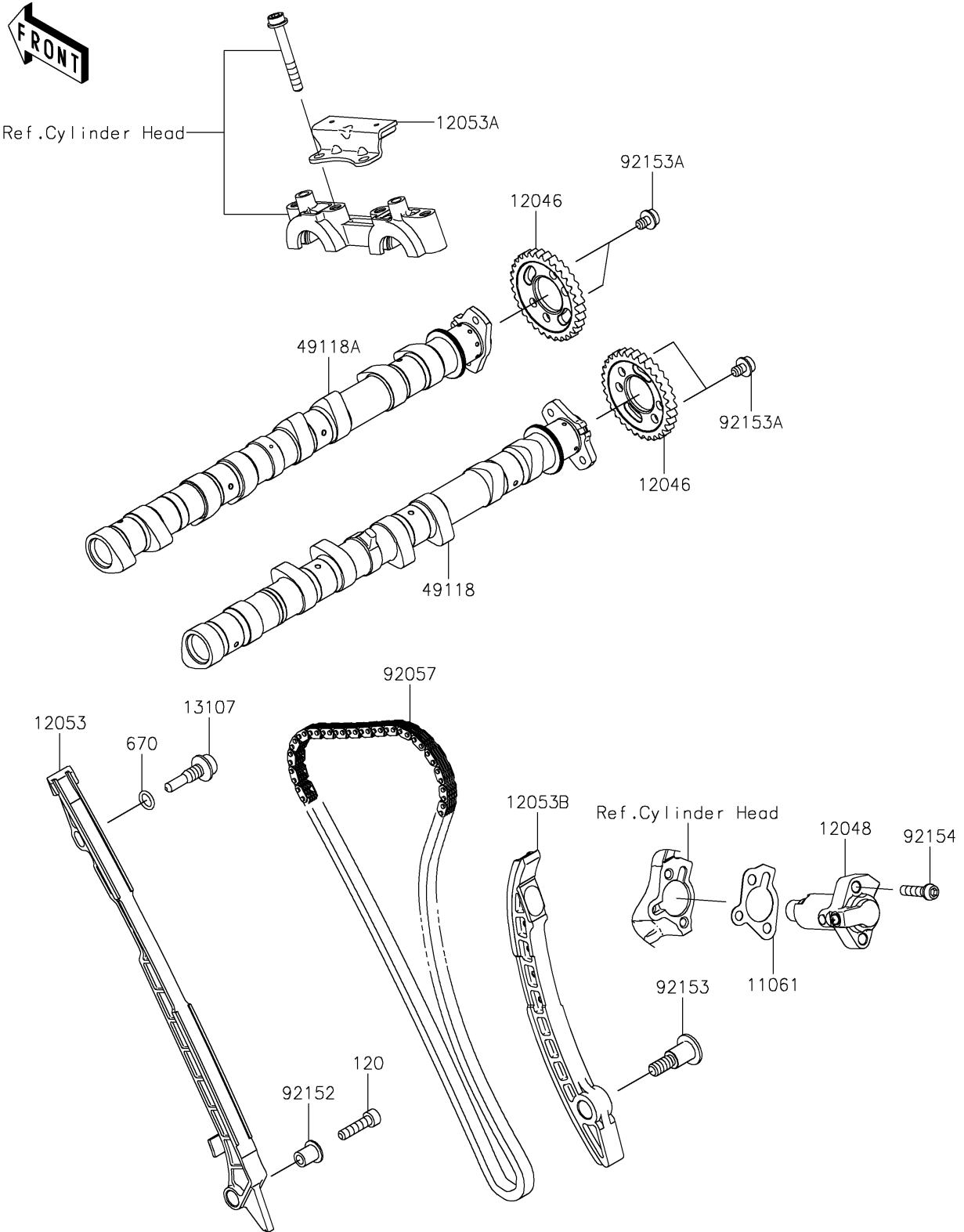

## 2022 Z H2 SE PARTS LIST

### Camshaft(s)/Tensioner

ITEM NAME	PART NUMBER	QUANTITY
GASKET,TENSIONER (Ref # 11061)	11061-0796	1
SPROCKET,32T (Ref # 12046)	12046-0601	2
TENSIONER-ASSY (Ref # 12048)	12048-0120	1
GUIDE-CHAIN,FR (Ref # 12053)	12053-0251	1
GUIDE-CHAIN,UPP (Ref # 12053A)	12053-0297	1
GUIDE-CHAIN,RR (Ref # 12053B)	12053-0333	1
SHAFT,CHAIN GUIDE (Ref # 13107)	13107-0157	1
CAMSHAFT-COMP,INTAKE (Ref # 49118)	49118-0993	1
CAMSHAFT-COMP,EXHAUST (Ref # 49118A)	49118-0994	1
CHAIN,98XRH2015-126M (Ref # 92057)	92057-0202	1
COLLAR (Ref # 92152)	92152-0413	1
BOLT,SOCKET,8X16.7 (Ref # 92153)	92153-0446	1
BOLT,FLANGED,6X8 (Ref # 92153A)	92153-0455	4
BOLT,SOCKET,6X25 (Ref # 92154)	92154-1457	2
BOLT-SOCKET,6X25 (Ref # 120)	120CA0625	1
O RING,9MM (Ref # 670)	670D1509	1