

# 2025 Z H2 SE PARTS DIAGRAM

## Crankcase Bolt Pattern

E1412

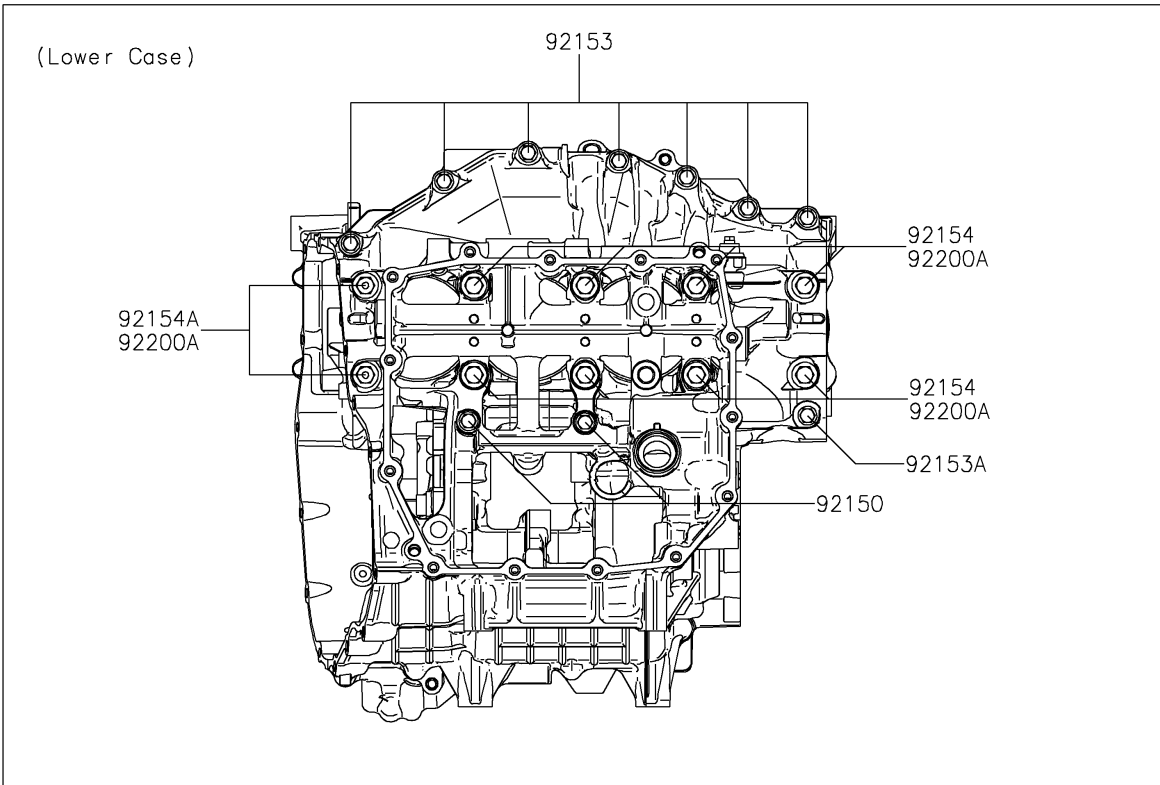
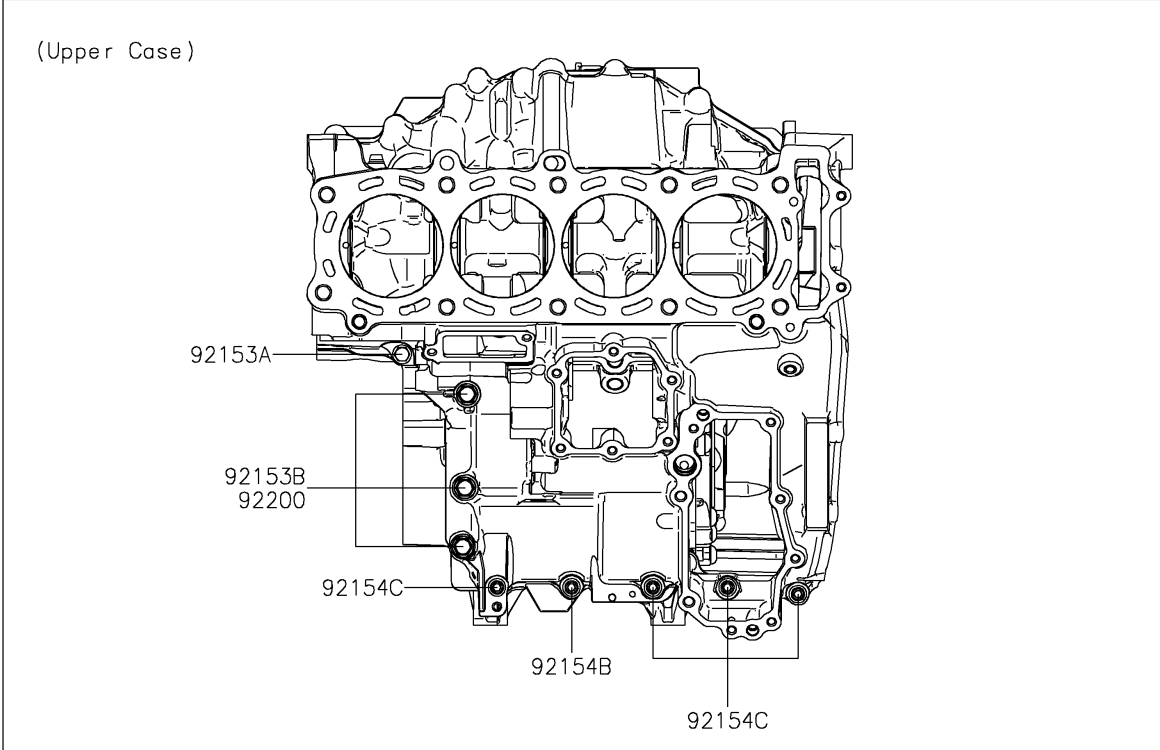

## 2025 Z H2 SE PARTS LIST

### Crankcase Bolt Pattern

ITEM NAME	PART NUMBER	QUANTITY
BOLT,FLANGED,7X85 (Ref # 92150)	92150-1251	2
BOLT,FLANGED,7X45 (Ref # 92153)	92153-1041	7
BOLT,FLANGED,7X60 (Ref # 92153A)	92153-1045	2
BOLT,8X63 (Ref # 92153B)	92153-1110	3
BOLT,FLANGED,10X100 (Ref # 92154)	92154-1446	8
BOLT,FLANGED,10X120 (Ref # 92154A)	92154-1447	2
BOLT,SOCKET,6X30 (Ref # 92154B)	92154-1463	1
BOLT,SOCKET,6X40 (Ref # 92154C)	92154-1465	4
WASHER,8.2X16X1.6 (Ref # 92200)	92200-0047	3
WASHER,10.2X18.4X1.8 (Ref # 92200A)	92200-0990	10