

# 2025 Z H2 SE PARTS DIAGRAM

Brake Pedal/Torque Link

F2260

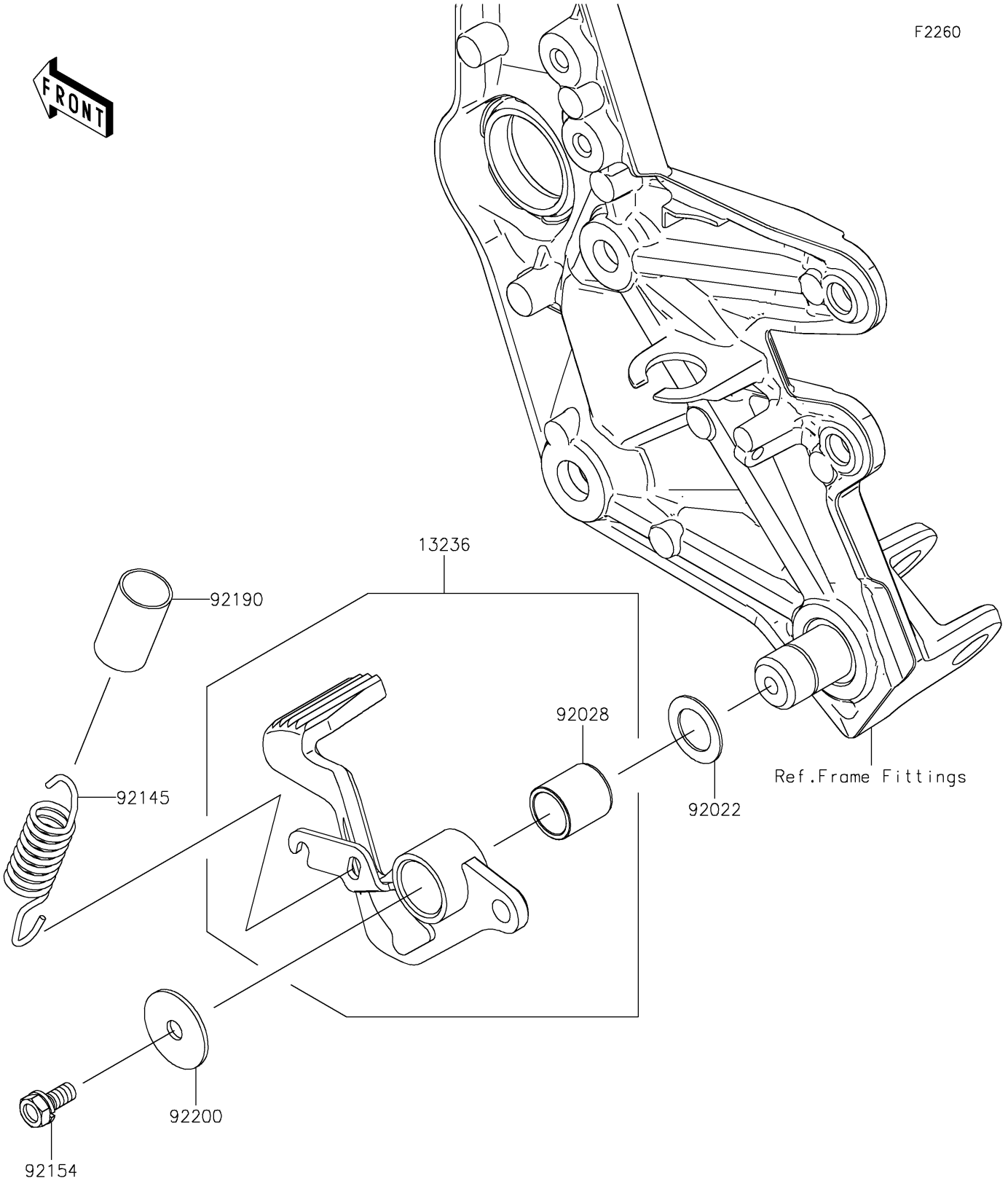

## 2025 Z H2 SE PARTS LIST

### Brake Pedal/Torque Link

ITEM NAME	PART NUMBER	QUANTITY
LEVER-COMP,BRAKE PEDAL (Ref # 13236)	13236-0823	1
WASHER,15.3X24X1 (Ref # 92022)	92022-326	1
BUSHING,BRAKE PEDAL (Ref # 92028)	92028-1282	1
SPRING (Ref # 92145)	92145-1907	1
BOLT,UPSET-WS,6X14 (Ref # 92154)	92154-0293	1
TUBE,16X19X30 (Ref # 92190)	92190-1185	1
WASHER,7X28X1.6 (Ref # 92200)	92200-0279	1