

2023 W800 PARTS DIAGRAM

Chassis Electrical Equipment

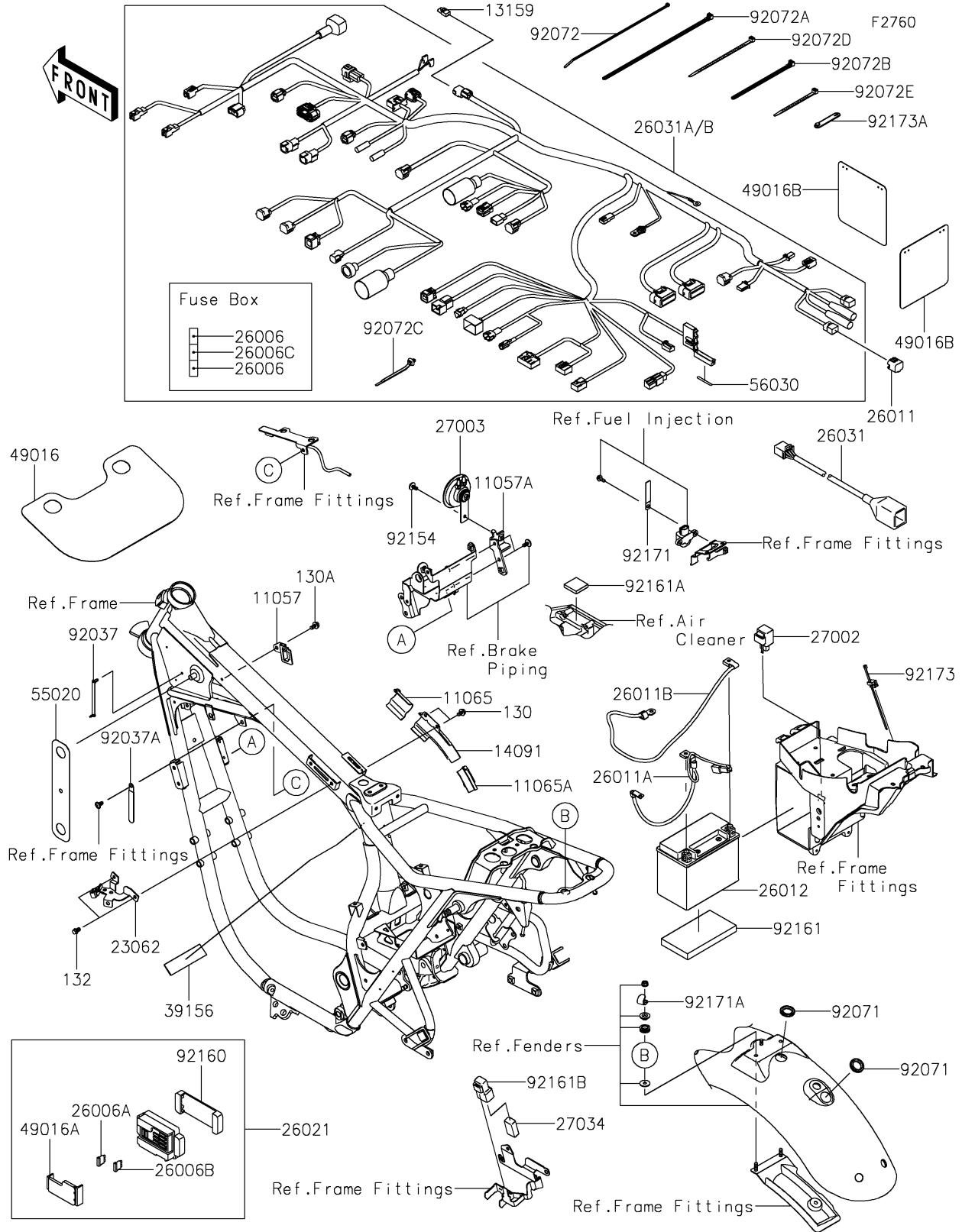

2023 W800 PARTS LIST

Chassis Electrical Equipment

ITEM NAME	PART NUMBER	QUANTITY
BRACKET,IGNITION SWITCH (Ref # 11057)	11057-2407	1
BRACKET,HORN (Ref # 11057A)	11057-7971	1
CAP,HARNESS COVER,FR (Ref # 11065)	11065-1141	1
CAP,HARNESS COVER,RR (Ref # 11065A)	11065-1142	1
CONNECTOR,GRIP HEATER COUPLER (Ref # 13159)	13159-0034	1
COVER,HARNESS (Ref # 14091)	14091-1274	1
BRACKET-COMP,PRESSURE SENSOR (Ref # 23062)	23062-1252	1
FUSE,MINI BLADE,15A,BLUE (Ref # 26006)	26006-0001	2
FUSE,BLADE,30A,GREEN (Ref # 26006A)	26006-1067	1
FUSE,10A-R (Ref # 26006B)	26006-1068	8
FUSE,MINI BLADE,10A,RED (Ref # 26006C)	26006-1078	1
WIRE-LEAD,CONNECTOR COVER (Ref # 26011)	26011-0275	1
WIRE-LEAD,BATTERY(+) (Ref # 26011A)	26011-1868	1
WIRE-LEAD,BATTERY(-) (Ref # 26011B)	26011-1893	1
BATTERY,YTX12-BS,12V 10AH (Ref # 26012)	26012-1514	1
JUNCTION BOX (Ref # 26021)	26021-0085	1
HARNESS,RR (Ref # 26031)	26031-2505	1
HARNESS,MAIN (Ref # 26031A)	26031-2650	1
HARNESS,MAIN (Ref # 26031B)	26031-2651	1
RELAY-ASSY,TURN SIGNAL (Ref # 27002)	27002-1101	1
HORN (Ref # 27003)	27003-0166	1
RELAY (Ref # 27034)	27034-0012	1
PAD,25X100X2 (Ref # 39156)	39156-2527	1
COVER-SEAL (Ref # 49016)	49016-0571	1
COVER-SEAL,FUSE (Ref # 49016A)	49016-0670	1
COVER-SEAL (Ref # 49016B)	49016-0671	2
GUARD (Ref # 55020)	55020-1985	1
LABEL,FUSE BOX1 (Ref # 56030)	56030-1493	1
CLAMP,SPEED,L=80.5 (Ref # 92037)	92037-1903	1

2023 W800 PARTS LIST

Chassis Electrical Equipment

ITEM NAME	PART NUMBER	QUANTITY
CLAMP (Ref # 92037A)	92037-1993	1
GROMMET,18X29X5 (Ref # 92071)	92071-0054	2
BAND (Ref # 92072)	92072-0863	1
BAND,L=250 (Ref # 92072A)	92072-1237	1
BAND,L=140 (Ref # 92072B)	92072-1293	2
BAND,OS170-FT7(BLACK) (Ref # 92072C)	92072-1414	AR
BAND,L=152 (Ref # 92072D)	92072-3874	5
BAND,L=100 (Ref # 92072E)	92072-3875	2
BOLT,SOCKET,6X12 (Ref # 92154)	92154-2706	1
DAMPER,JUNCTION BOX (Ref # 92160)	92160-1650	1
DAMPER,BATTERY (Ref # 92161)	92161-0018	1
DAMPER,34X34X7 (Ref # 92161A)	92161-2289	1
DAMPER (Ref # 92161B)	92161-2290	1
CLAMP,L=60 (Ref # 92171)	92171-0652	1
CLAMP (Ref # 92171A)	92171-1918	1
CLAMP (Ref # 92173)	92173-0791	1
CLAMP (Ref # 92173A)	92173-1526	1
BOLT-FLANGED,6X10 (Ref # 130)	130BA0610	2
BOLT-FLANGED,6X12 (Ref # 130A)	130BA0612	1
BOLT-FLANGED-SMALL,6X10 (Ref # 132)	132BA0610	2